

FEATURES

- Quad 2:1 mux/1:2 demux**
- Optimized for dc to 6.5 Gbps NRZ data**
- Per-lane P/N pair inversion for routing ease**
- Programmable input equalization**
 - Compensates up to 40 inches of FR4
- Loss-of-signal detection**
- Programmable output pre-emphasis up to 12 dB**
- Programmable output levels with squelch and disable**
- Accepts ac-coupled or dc-coupled differential CML inputs**
- 50 Ω on-chip termination**
- 1:2 demux supports unicast or bicast operation**
- Port-level loopback**
- Port or single lane switching**
- 1.8 V to 3.3 V flexible core supply**
- User-settable I/O supply from V_{CC} to 1.2 V**
- Low power, typically 2.0 W in basic configuration**
- 100-lead LFCSP**
- 40°C to +85°C operating temperature range**

APPLICATIONS

- Low cost redundancy switch**
- SONET OC48/SDH16 and lower data rates**
- XAUI/GbE/FC/Infiniband over backplane**
- OIF CEI 6.25 Gbps over backplane**
- Serial data-level shift**
- 4-/8-/12-lane equalizers or redrivers**

GENERAL DESCRIPTION

The AD8158 is an asynchronous, protocol-agnostic, quad-lane 2:1 switch with a total of 12 differential CML inputs and 12 differential CML outputs. The signal path supports NRZ signaling with data rates up to 6.5 Gbps per lane. Each lane offers programmable receive equalization, programmable output pre-emphasis, programmable output levels, and loss-of-signal detection.

The nonblocking switch-core of the AD8158 implements a 2:1 multiplexer and 1:2 demultiplexer per lane and supports independent lane switching through the four select pins, SEL[3:0]. Each port is a four-lane link. Every lane implements an asynchronous path supporting dc to 6.5 Gbps NRZ data, fully independent of other lanes. The AD8158 has low latency and very low lane-to-lane skew.

The main application of the AD8158 is to support redundancy on both the backplane and the line interface sides of a serial link. The demultiplexing path implements unicast and bicast

Rev. 0

Information furnished by Analog Devices is believed to be accurate and reliable. However, no responsibility is assumed by Analog Devices for its use, nor for any infringements of patents or other rights of third parties that may result from its use. Specifications subject to change without notice. No license is granted by implication or otherwise under any patent or patent rights of Analog Devices. Trademarks and registered trademarks are the property of their respective owners.

FUNCTIONAL BLOCK DIAGRAM

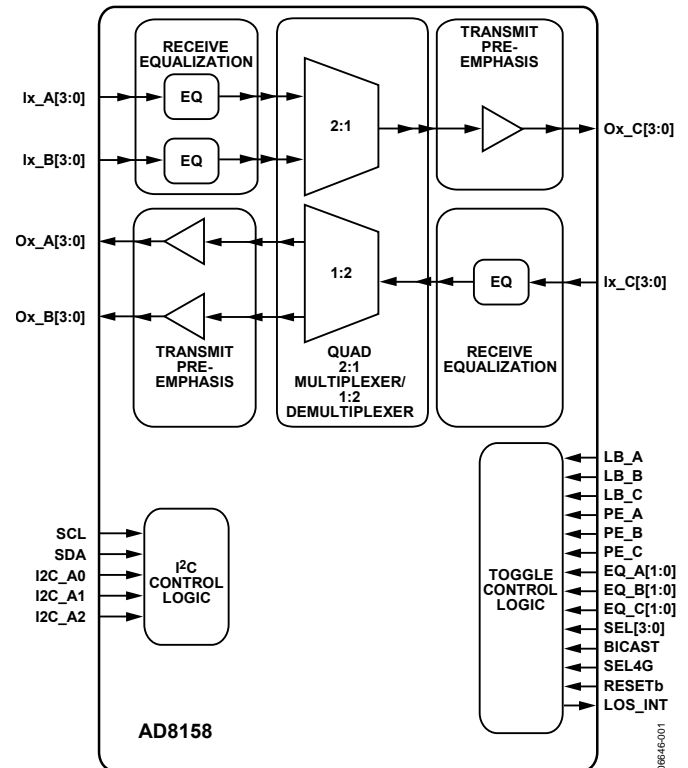

Figure 1.

capability, allowing the part to support either 1 + 1 or 1:1 redundancy.

The AD8158 is also suited for testing high speed serial links because of its ability to duplicate incoming data. In a port-monitoring application, the AD8158 can maintain link-connectivity with a pass-through connection from Port C to Port A while sending a duplicate copy of the data to test equipment on Port B.

The rich feature set of the AD8158 can be controlled either through external toggle pins or by setting on-chip control registers through the I²C® interface.

TABLE OF CONTENTS

Features	1	Pre-Emphasis	21
Applications.....	1	Output Compliance, AC vs. DC Coupling, Minimum Supply Voltage, and the TX_HEADROOM Bit	23
Functional Block Diagram	1	Signal Levels and Common-Mode Shift for AC-Coupled and DC-Coupled Outputs	24
General Description	1	Squelch and Disable	26
Revision History	2	Speed Select.....	26
Specifications.....	3	AD8158 Power Consumption	26
I ² C Timing Specifications.....	4	Outputs	28
Absolute Maximum Ratings.....	5	Power Saving Considerations	28
ESD Caution.....	5	I ² C Control Interface.....	29
Pin Configuration and Function Descriptions.....	6	Serial Interface General Functionality.....	29
Typical Performance Characteristics	9	I ² C Interface Data Transfers: Data Write	29
Theory of Operation	15	I ² C Interface Data Transfers: Data Read	30
The Switch (Mux/Demux/Unicast/Bicast/Loopback).....	16	Applications Information	31
Receivers	18	Supply Sequencing	31
Lane Disables	19	Single Supply vs. Multiple Supply Operation	31
Equalizer Settings	19	Register Map	32
Loss of Signal (LOS).....	19	Outline Dimensions	34
Lane Inversion: P/N Swap	21	Ordering Guide	34
Transmitters	21		
Output Level Programming and Output Structure	21		

REVISION HISTORY**6/08—Revision 0: Initial Version**

SPECIFICATIONS

$V_{CC} = V_{TTI} = V_{TTO} = 1.8$ V, $DV_{CC} = 3.3$ V, $V_{EE} = 0$ V, $R_L = 50$ Ω , basic configuration¹, data rate = 6.5 Gbps, ac-coupled differential input swing = 800 mV p-p, $T_A = 25^\circ\text{C}$, unless otherwise noted.

Table 1.

Parameter	Conditions	Min	Typ	Max	Unit
DYNAMIC PERFORMANCE					
Data Rate/Channel (NRZ)		DC		6.5	Gbps
Deterministic Jitter (No Channel)	Data rate = 6.5 Gbps, EQ enabled		20		ps p-p
Random Jitter (No Channel)	RMS, data rate = 6.5 Gbps		1		ps
Residual Deterministic Jitter with Receive Equalization	Data rate 6.5 Gbps, 20 inch FR4		30		ps p-p
	Data rate 6.5 Gbps, 40 inch FR4		40		ps p-p
Residual Deterministic Jitter with Transmit Pre-Emphasis	Data rate 6.5 Gbps, 10 inch FR4		35		ps p-p
	Data rate 6.5 Gbps, 30 inch FR4		42		ps p-p
Propagation Delay	50% input to 50% output (maximum EQ)		700		ps
Lane-to-Lane Skew	Signal path and switch architecture is balanced and symmetric (maximum EQ)		90		ps
Switching Time	50% logic switching to 50% output data		150		ns
Output Rise/Fall Time	20% to 80% (PE = lowest setting)		62		ps
INPUT CHARACTERISTICS					
Differential Input Voltage Swing	$V_{ICM}^2 = V_{CC} - 0.6$ V, $V_{CC} = V_{MIN}$ to V_{MAX} , $T_A = T_{MIN}$ to T_{MAX} , LOS threshold register = 0x10, LOS control register = 0x05	200		2000	mV p-p
Differential Sensitivity with Default LOS Setting			300		mV p-p
Input Voltage Range	Single-ended absolute voltage level, V_L minimum		$V_{EE} + 0.6$		V
	Single-ended absolute voltage level, V_H maximum		$V_{CC} + 0.3$		V
OUTPUT CHARACTERISTICS					
Output Voltage Swing	Differential, PE = 0, default output level, @ dc	590	725	820	mV p-p
Output Voltage Range	Single-ended absolute voltage level, TX_HEADROOM = 0; V_L minimum		$V_{CC} - 1.1$		V
	Single-ended absolute voltage level, TX_HEADROOM = 0; V_H maximum		$V_{CC} + 0.6$		V
	Single-ended absolute voltage level, TX_HEADROOM = 1; V_L minimum		$V_{CC} - 1.3$		V
	Single-ended absolute voltage level, TX_HEADROOM = 1; V_H maximum		$V_{CC} + 0.6$		V
Output Current	Port A/B/C, PE_A/B/C = minimum		16		mA
Output Current	Port A/B/C, PE_A/B/C = 6 dB, $V_{OD} = 800$ mV p-p		32		mA
TERMINATION CHARACTERISTICS					
Resistance	Differential, $V_{CC} = V_{MIN}$ to V_{MAX} , $T_A = T_{MIN}$ to T_{MAX}	90	100	110	Ω
LOS CHARACTERISTICS					
Assert Level	LOS threshold = 0x10 LOS_GSEL = 0, @ dc		25		mV diff
Deassert Level	LOS_GSEL = 0, @ dc		150		mV diff
LOS to Output Squelch	LOS control = 0, $V_{ID} = 0$ to 50% OP/ON settling, $V_{CC} = 1.8$ V		21		ns
LOS to Output Enable	LOS control = 0, data present to first valid transition, $V_{CC} = 1.8$ V		67		ns
POWER SUPPLY					
Operating Range					
V_{CC}	$V_{EE} = 0$ V, TX_HEADROOM = 0	1.6	1.8 to 3.3	3.6	V
V_{CC}	$V_{EE} = 0$ V, TX_HEADROOM = 1	2.2	3.3	3.6	V
DV_{CC}	$DV_{CC} \geq V_{CC}$, $V_{EE} = 0$ V	1.6	1.8 to 3.3	3.6	V
V_{TTI}		1.2		$V_{CC} + 0.3$	V
V_{TTO}		1.2		$V_{CC} + 0.3$	V

AD8158

Parameter	Conditions	Min	Typ	Max	Unit
Supply Current	DC-coupled inputs/outputs, 400 mV I/O swings (800 mV p-p differential), 50 Ω far-end terminations				
I_{CC}			354	450	mA
I_{TIO}			128	150	mA
I_{TI}			94	107	mA
I_{DVCC}			2	4	mA
Supply Current	LB_x = 1, PE = 6 dB on all ports, dc-coupled inputs/outputs, 400 mV I/O swings (800 mV p-p differential), 50 Ω far-end terminations				
I_{CC}			730	850	mA
I_{TIO}			367	420	mA
I_{TI}			95	107	mA
I_{DVCC}			2	4	mA
THERMAL CHARACTERISTICS					
Operating Temperature Range		-40		+85	°C
θ_{JA}	Still air; JEDEC four-layer test board, ePAD soldered		22.2		°C/W
θ_{JC}	Still air; thermal resistance through exposed pad		1.4		°C/W
Maximum Junction Temperature				125	°C
LOGIC INPUT CHARACTERISTICS³					
Input High (V_{IH})	$DV_{CC} = 3.3\text{ V}$	$0.7 \times DV_{CC}$		DV_{CC}	V
Input Low (V_{IL})	$DV_{CC} = 3.3\text{ V}$	V_{EE}		$0.3 \times DV_{CC}$	V
Input High (V_{IH})	$DV_{CC} = 1.8\text{ V}$		$0.8 \times DV_{CC}$	DV_{CC}	V
Input Low (V_{IL})	$DV_{CC} = 1.8\text{ V}$	V_{EE}	$0.2 \times DV_{CC}$		V

¹ Bicast is off, loopback is off on all ports, pre-emphasis is set to minimum on all ports, and equalization is set to minimum on all ports.

² V_{ICM} is the input common-mode voltage.

³ EQ control pins (EQ_A0, EQ_A1, EQ_B0, EQ_B1, EQ_C0, EQ_C1) require 5 kΩ in series when $DV_{CC} > V_{CC}$.

I²C TIMING SPECIFICATIONS

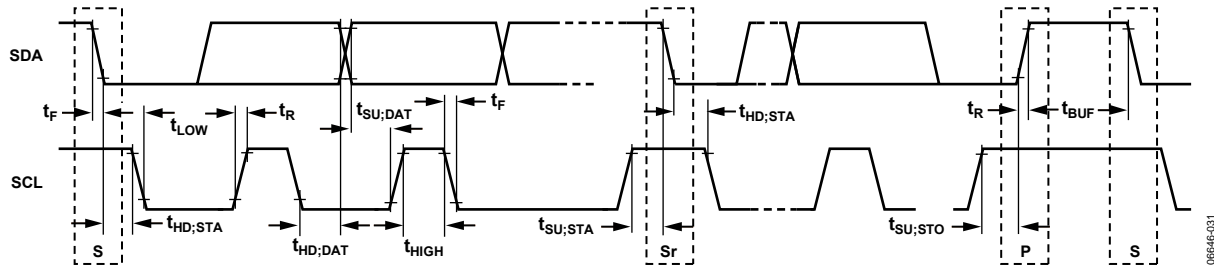

Figure 2. I²C Timing Diagram

Table 2. I²C Timing Parameters

Parameter	Symbol	Min	Max	Unit
SCL Clock Frequency	f_{SCL}	0	400+	kHz
Hold Time for a Start Condition	$t_{HD,STA}$	0.6		μs
Setup Time for a Repeated Start Condition	$t_{SU,STA}$	0.6		μs
Low Period of the SCL Clock	t_{LOW}	1.3		μs
High Period of the SCL Clock	t_{HIGH}	0.6		μs
Data Hold Time	$t_{HD,DAT}$	0		μs
Data Setup Time	$t_{SU,DAT}$	10		ns
Rise Time for Both SDA and SCL	t_R	1	300	ns
Fall Time for Both SDA and SCL	t_F	1	300	ns
Setup Time for Stop Condition	$t_{SU,STO}$	0.6		μs
Bus Free Time Between a Stop and a Start Condition	t_{BUF}	1		ns
Capacitance for Each I/O Pin	C_i	5	7	pF

ABSOLUTE MAXIMUM RATINGS

Table 3.

Parameter	Rating
V_{CC} to V_{EE}	3.7 V
DV_{CC} to V_{EE}	3.7 V
V_{TI}	Lower of ($V_{CC} + 0.6$ V) or 3.6 V
V_{TTO}	Lower of ($V_{CC} + 0.6$ V) or 3.6 V
V_{CC} to DV_{CC}	0.6 V
Internal Power Dissipation	4.26 W
Differential Input Voltage	2.0 V
Logic Input Voltage	$V_{EE} - 0.3$ V < V_{IN} < $V_{CC} + 0.6$ V
Storage Temperature Range	-65°C to +125°C
Lead Temperature	300°C

Stresses above those listed under Absolute Maximum Ratings may cause permanent damage to the device. This is a stress rating only; functional operation of the device at these or any other conditions above those indicated in the operational section of this specification is not implied. Exposure to absolute maximum rating conditions for extended periods may affect device reliability.

ESD CAUTION



ESD (electrostatic discharge) sensitive device. Charged devices and circuit boards can discharge without detection. Although this product features patented or proprietary protection circuitry, damage may occur on devices subjected to high energy ESD. Therefore, proper ESD precautions should be taken to avoid performance degradation or loss of functionality.

PIN CONFIGURATION AND FUNCTION DESCRIPTIONS

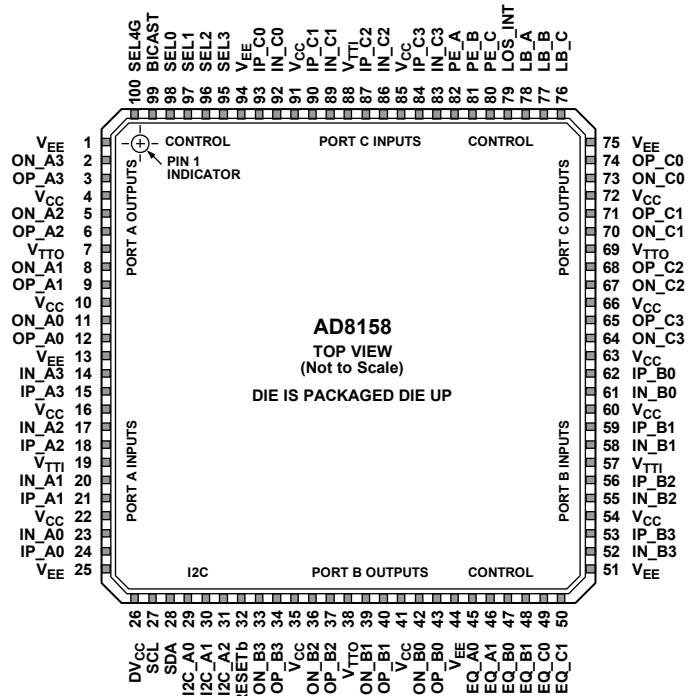

NOTES
 1. THE ePAD ON THE BOTTOM OF THE PACKAGE MUST BE ELECTRICALLY CONNECTED TO VEE.

Figure 3. Pin Configuration

Table 4. Pin Function Descriptions

Pin No.	Mnemonic	Type	Description
1, 13, 25, 44, 51, 75, 94, ePAD	V _{EE}	Power	Negative Supply
2	ON_A3	Output	High Speed Output Complement
3	OP_A3	Output	High Speed Output
4, 10, 16, 22, 35, 41, 54, 60, 63, 66, 72, 85, 91	V _{CC}	Power	Positive Supply
5	ON_A2	Output	High Speed Output Complement
6	OP_A2	Output	High Speed Output
7, 38, 69	V _{TTO}	Power	Port A, Port B, and Port C Output Termination Supply
8	ON_A1	Output	High Speed Output Complement
9	OP_A1	Output	High Speed Output
11	ON_A0	Output	High Speed Output Complement
12	OP_A0	Output	High Speed Output
14	IN_A3	Input	High Speed Input Complement
15	IP_A3	Input	High Speed Input
17	IN_A2	Input	High Speed Input Complement
18	IP_A2	Input	High Speed Input
19, 57, 88	V _{TTI}	Power	Port A, Port B, and Port C Input Termination Supply
20	IN_A1	Input	High Speed Input Complement
21	IP_A1	Input	High Speed Input
23	IN_A0	Input	High Speed Input Complement
24	IP_A0	Input	High Speed Input
26	DV _{CC}	Power	Digital Power Supply

Pin No.	Mnemonic	Type	Description
27	SCL	I ² C	I ² C Clock Pin
28	SDA	I ² C	I ² C Data Pin
29	I2C_A0	I ² C	I ² C Address Pin (LSB)
30	I2C_A1	I ² C	I ² C Address Pin
31	I2C_A2	I ² C	I ² C Address Pin (MSB)
32	RESETb	Control ¹	Chip Reset. Active Low
33	ON_B3	Output	High Speed Output Complement
34	OP_B3	Output	High Speed Output
36	ON_B2	Output	High Speed Output Complement
37	OP_B2	Output	High Speed Output
39	ON_B1	Output	High Speed Output Complement
40	OP_B1	Output	High Speed Output
42	ON_B0	Output	High Speed Output Complement
43	OP_B0	Output	High Speed Output
45	EQ_A0 ²	Control ¹	Port A Equalizer Control Bit 0 (LSB)
46	EQ_A1 ²	Control ¹	Port A Equalizer Control Bit 1 (MSB)
47	EQ_B0 ²	Control ¹	Port B Equalizer Control Bit 0 (LSB)
48	EQ_B1 ²	Control ¹	Port B Equalizer Control Bit 1 (MSB)
49	EQ_C0 ²	Control ¹	Port C Equalizer Control Bit 0 (LSB)
50	EQ_C1 ²	Control ¹	Port C Equalizer Control Bit 1 (MSB)
52	IN_B3	Input	High Speed Input Complement
53	IP_B3	Input	High Speed Input
55	IN_B2	Input	High Speed Input Complement
56	IP_B2	Input	High Speed Input
58	IN_B1	Input	High Speed Input Complement
59	IP_B1	Input	High Speed Input
61	IN_B0	Input	High Speed Input Complement
62	IP_B0	Input	High Speed Input
64	ON_C3	Output	High Speed Output Complement
65	OP_C3	Output	High Speed Output
67	ON_C2	Output	High Speed Output Complement
68	OP_C2	Output	High Speed Output
70	ON_C1	Output	High Speed Output Complement
71	OP_C1	Output	High Speed Output
73	ON_C0	Output	High Speed Output Complement
74	OP_C0	Output	High Speed Output
76	LB_C	Control ¹	Loopback Enable for Port C
77	LB_B	Control ¹	Loopback Enable for Port B
78	LB_A	Control ¹	Loopback Enable for Port A
79	LOS_INT	Interrupt	Loss of Signal Interrupt, Active High
80	PE_C	Control ¹	Pre-Emphasis Control for Port C
81	PE_B	Control ¹	Pre-Emphasis Control for Port B
82	PE_A	Control ¹	Pre-Emphasis Control for Port A
83	IN_C3	Input	High Speed Input Complement
84	IP_C3	Input	High Speed Input
86	IN_C2	Input	High Speed Input Complement
87	IP_C2	Input	High Speed Input
89	IN_C1	Input	High Speed Input Complement
90	IP_C1	Input	High Speed Input
92	IN_C0	Input	High Speed Input Complement
93	IP_C0	Input	High Speed Input

AD8158

Pin No.	Mnemonic	Type	Description
95	SEL3	Control ¹	Lane 3 A/B Switch Control
96	SEL2	Control ¹	Lane 2 A/B Switch Control
97	SEL1	Control ¹	Lane 1 A/B Switch Control
98	SEL0	Control ¹	Lane 0 A/B Switch Control
99	BICAST	Control ¹	Enable Bicast Mode for Port A and Port B Outputs
100	SEL4G	Control ¹	Set Transmitter for Low Speed PE

¹ Logic level of control pins referred to DV_{CC}.

² EQ control pins (EQ_A0, EQ_A1, EQ_B0, EQ_B1, EQ_C0, EQ_C1) require 5 kΩ in series when DV_{CC} > V_{CC}.

TYPICAL PERFORMANCE CHARACTERISTICS

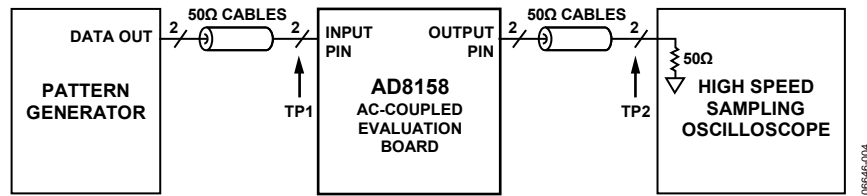

Figure 4. Standard Test Circuit (No Channel)

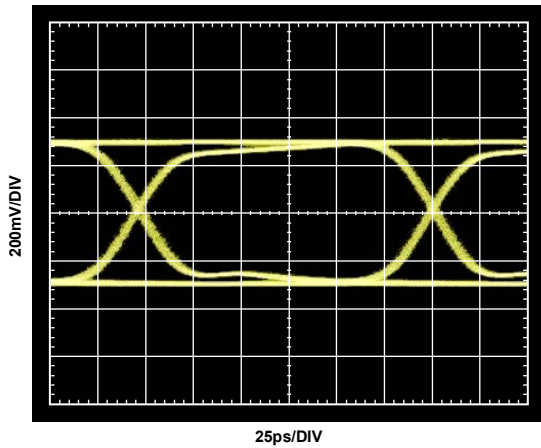

Figure 5. 6.5 Gbps Input Eye (TP1 from Figure 4)

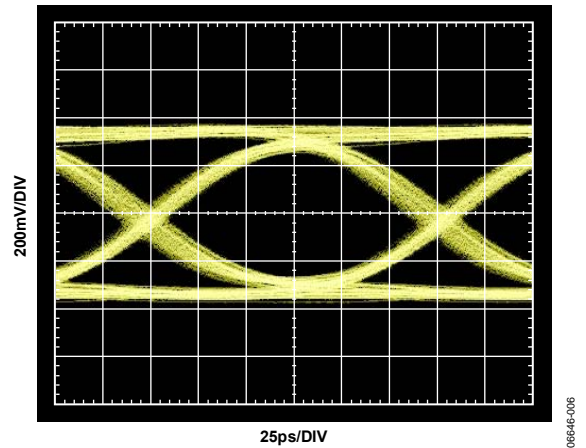

Figure 6. 6.5 Gbps Output Eye, No Channel (TP2 from Figure 4)

AD8158

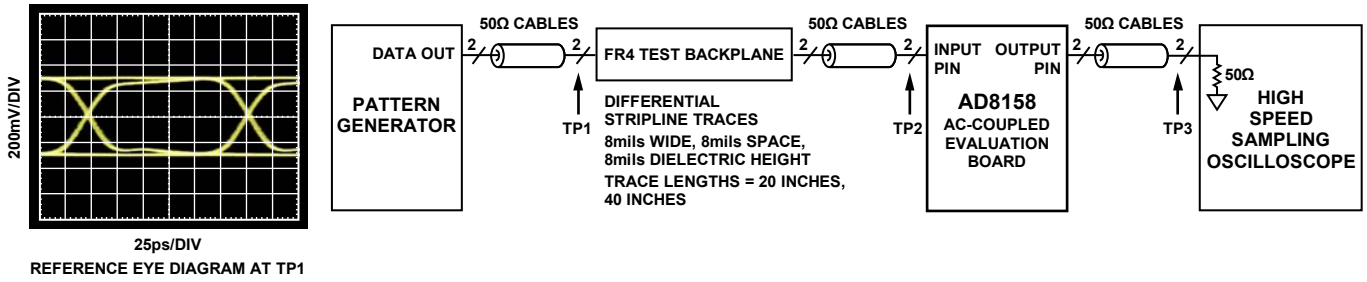

Figure 7. Input Equalization Test Circuit

06646-007

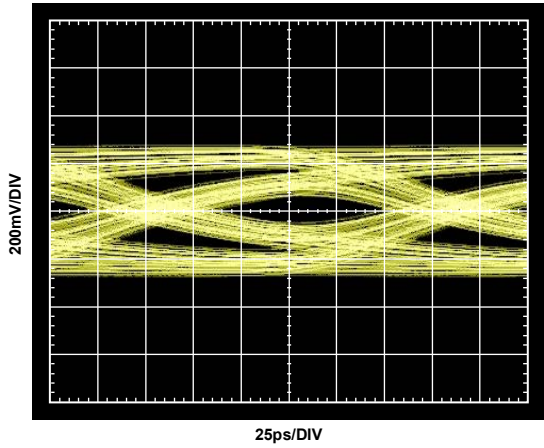

Figure 8. 6.5 Gbps Input Eye, 20 Inch FR4 Input Channel (TP2 from Figure 7)

06646-008

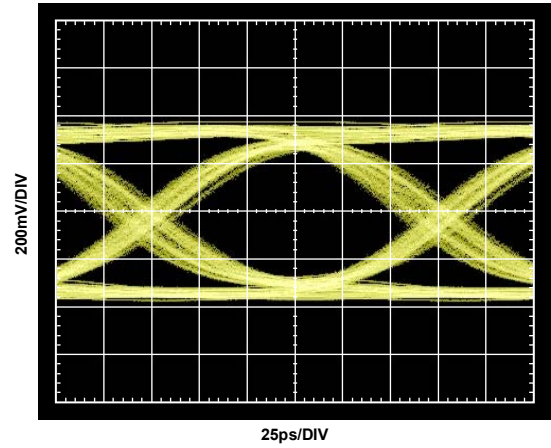

Figure 10. 6.5 Gbps Output Eye, 20 Inch FR4 Input Channel (TP3 from Figure 7)

06646-010

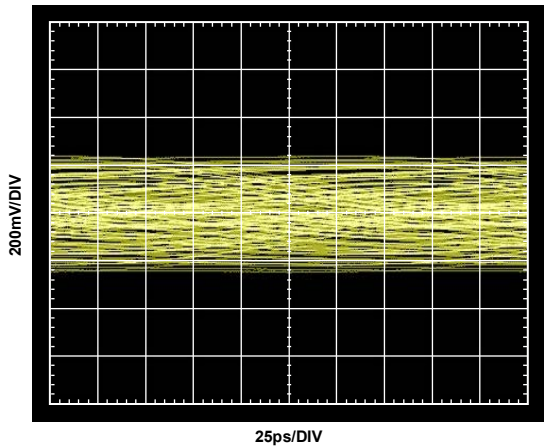

Figure 9. 6.5 Gbps Input Eye, 40 Inch FR4 Input Channel (TP2 from Figure 7)

06646-009

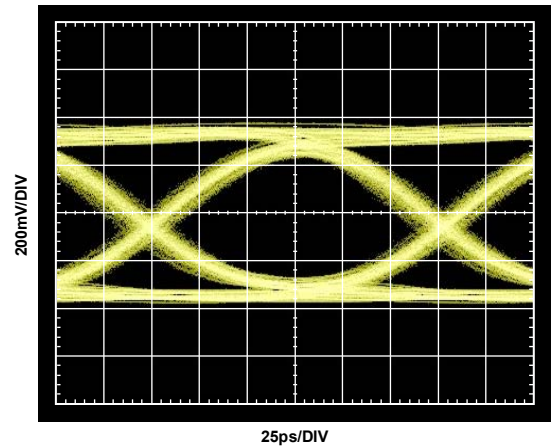

Figure 11. 6.5 Gbps Output Eye, 40 Inch FR4 Input Channel (TP3 from Figure 7)

06646-011

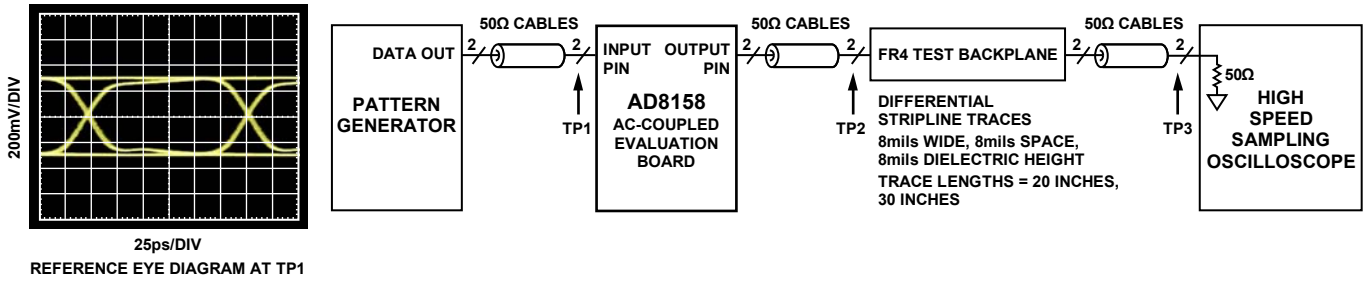

Figure 12. Output Pre-emphasis Test Circuit

06646-012

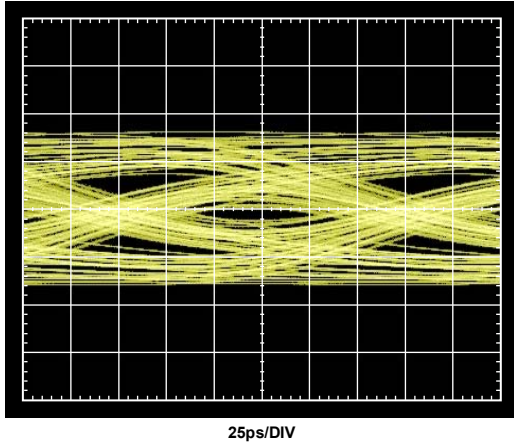

Figure 13. 6.5 Gbps Output Eye, 20 Inch FR4 Input Channel, PE = 0 (TP3 from Figure 12)

06646-013

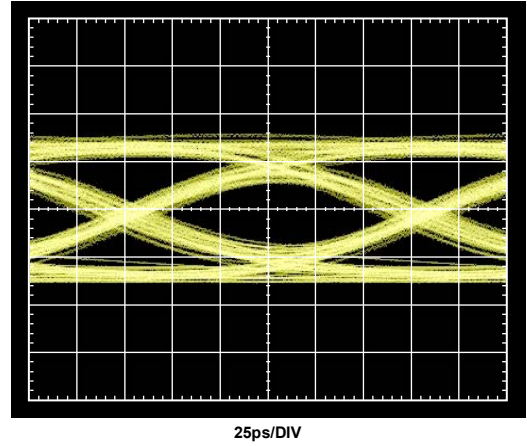

Figure 15. 6.5 Gbps Output Eye, 20 Inch FR4 Input Channel, PE = Best Setting, Default Output Level (TP3 from Figure 12)

06646-015

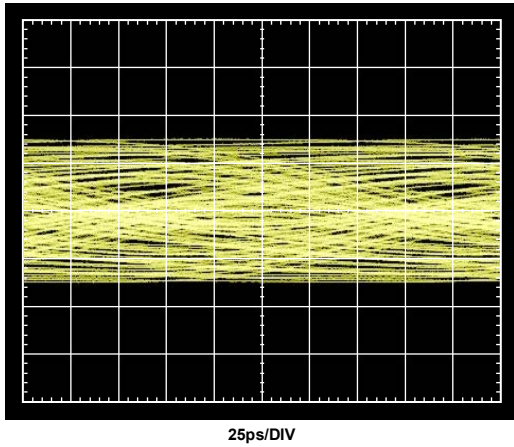

Figure 14. 6.5 Gbps Output Eye, 30 Inch FR4 Input Channel, PE = 0 (TP3 from Figure 12)

06646-014

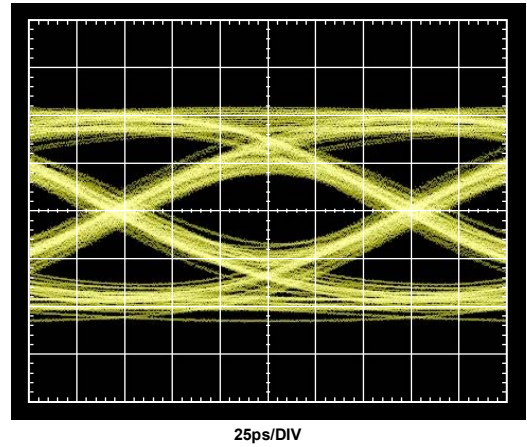

Figure 16. 6.5 Gbps Output Eye, 30 Inch FR4 Input Channel, PE = Best Setting, 200 mV Output Level (TP3 from Figure 12)

06646-016

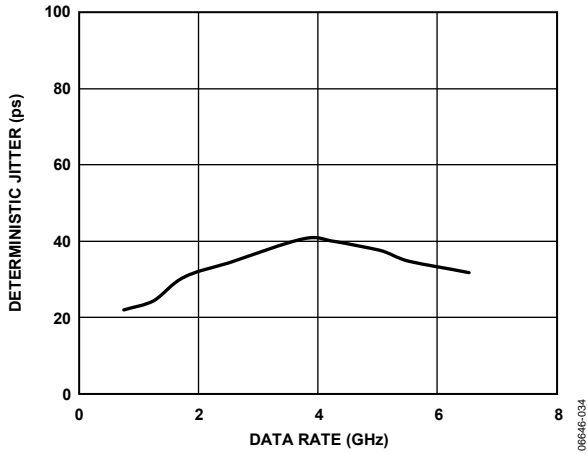

Figure 17. Deterministic Jitter vs. Data Rate

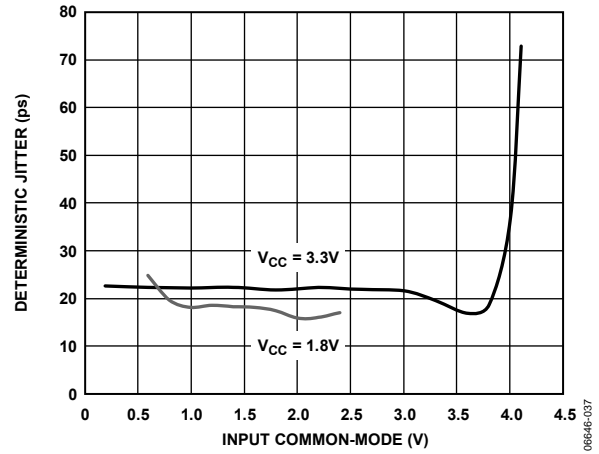

Figure 20. Deterministic Jitter vs. Input Common Mode

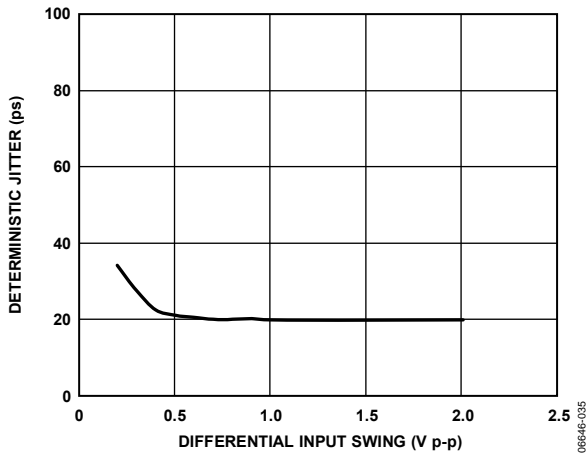

Figure 18. Deterministic Jitter vs. Input Swing

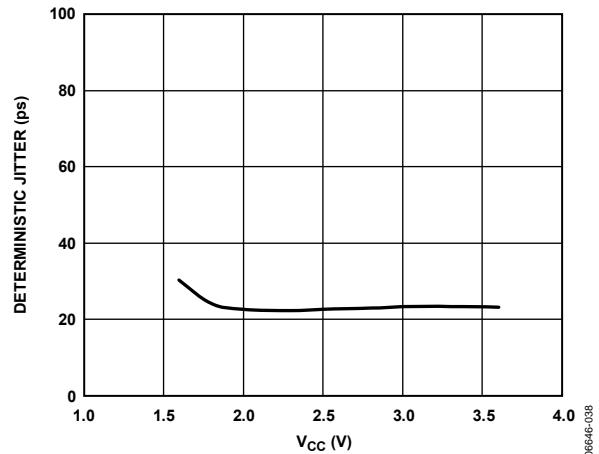

Figure 21. Deterministic Jitter vs. V_{CC}

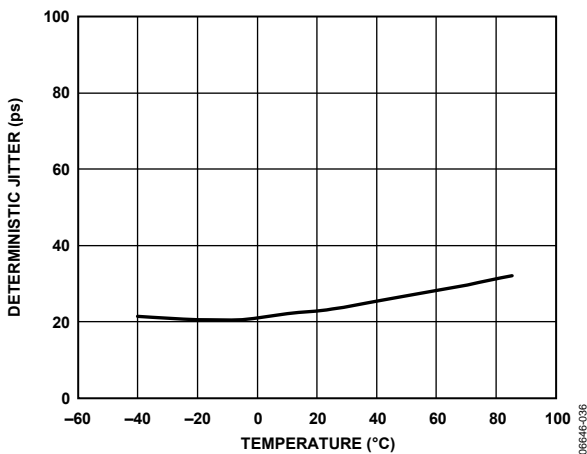

Figure 19. Deterministic Jitter vs. Temperature

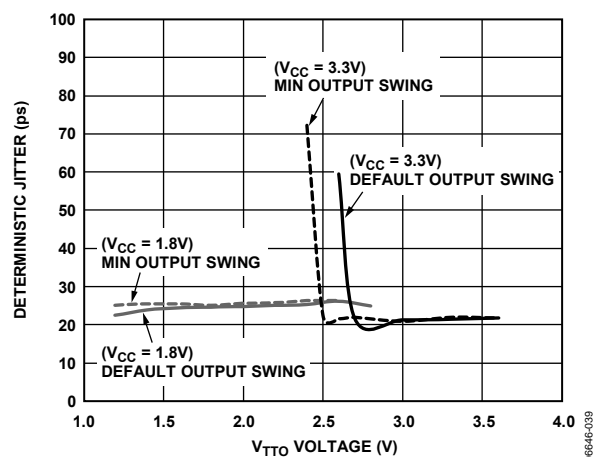

Figure 22. Deterministic Jitter vs. Output Termination Voltage (V_{TT0})

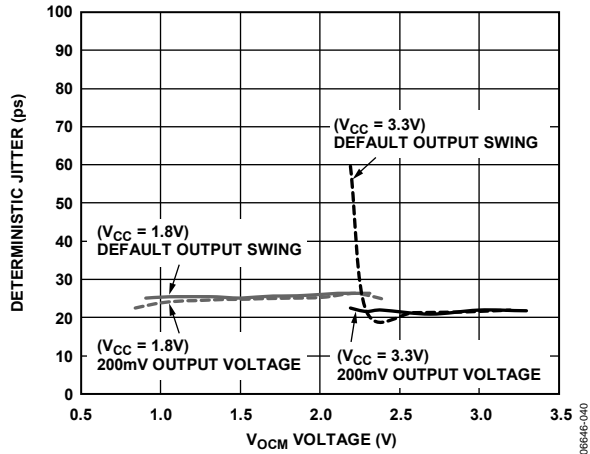

Figure 23. Deterministic Jitter vs. Output V_{OCM}

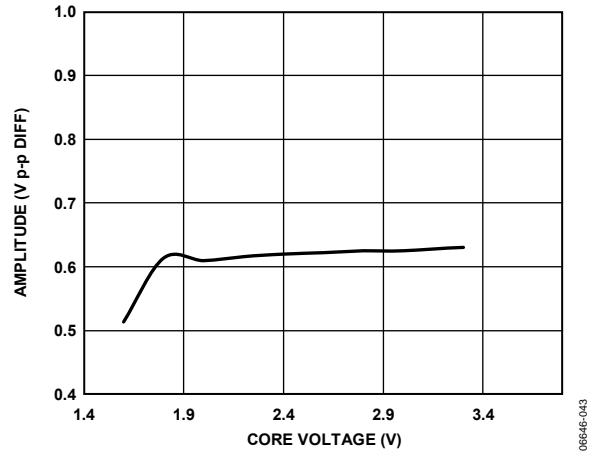

Figure 26. Output Amplitude (Default Setting) vs. Core Voltage

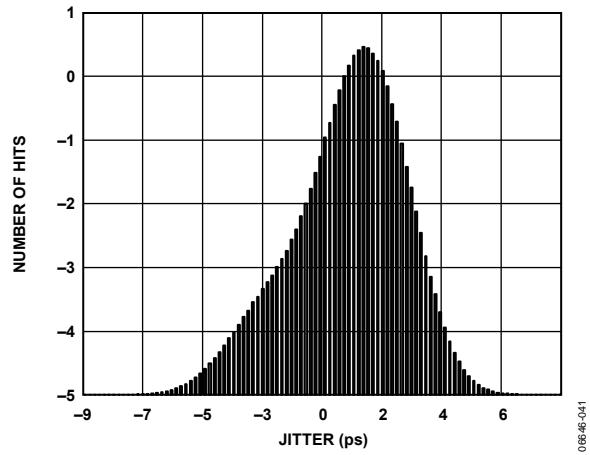

Figure 24. Random Jitter/Periodic Jitter Histogram

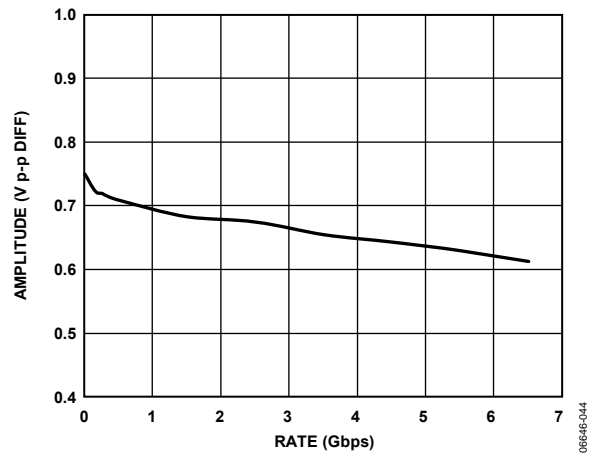

Figure 27. Output Amplitude vs. Rate

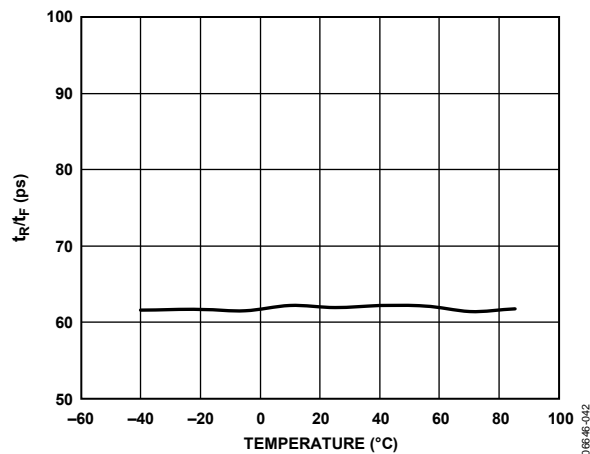

Figure 25. t_r/t_f vs. Temperature

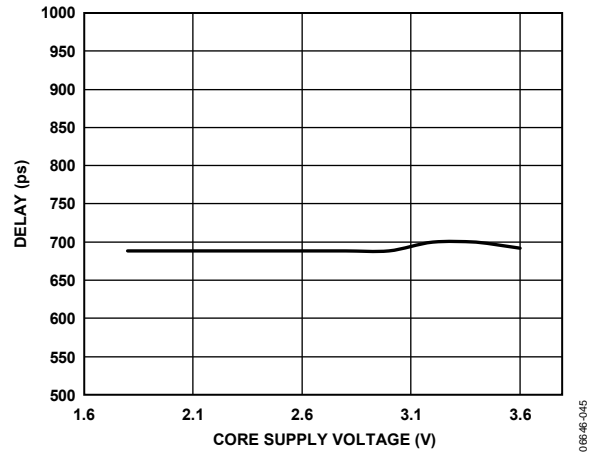

Figure 28. Propagation Delay vs. Core Supply

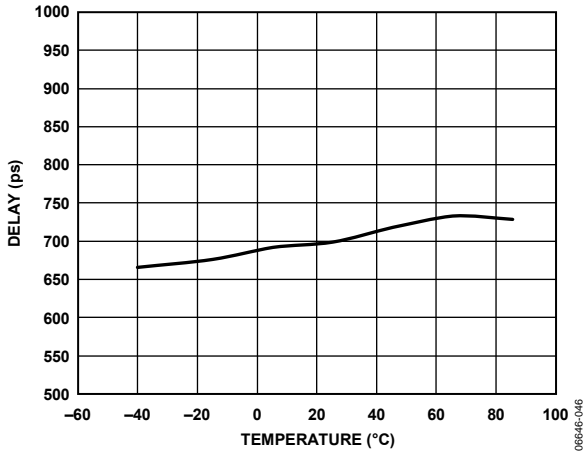

Figure 29. Propagation Delay vs. Temperature

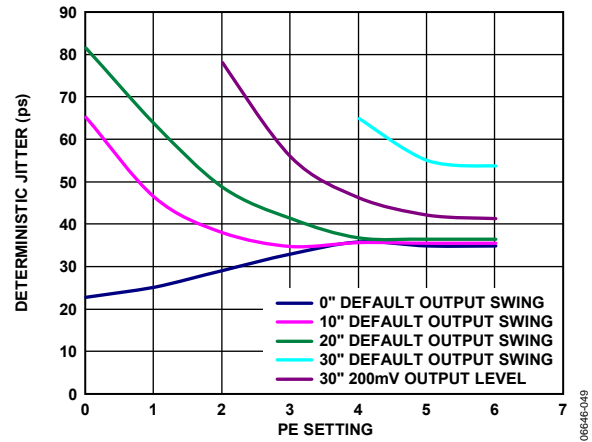

Figure 32. Deterministic Jitter vs. PE Setting

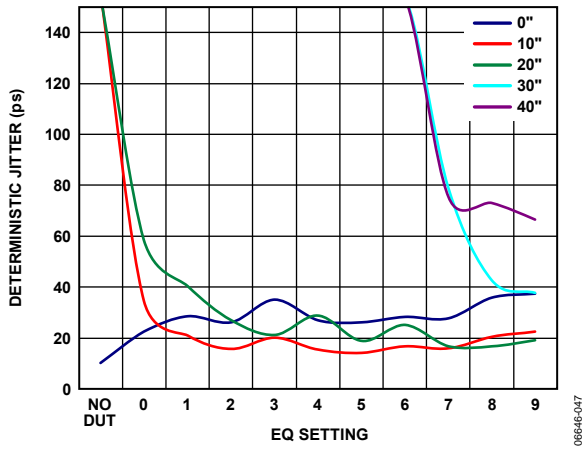

Figure 30. Deterministic Jitter vs. EQ Setting

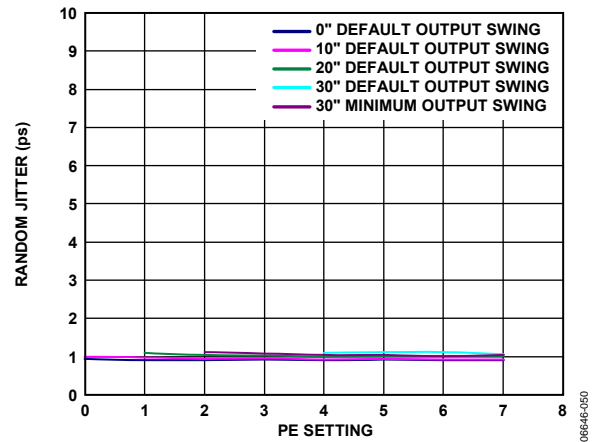

Figure 33. Random Jitter vs. PE Setting

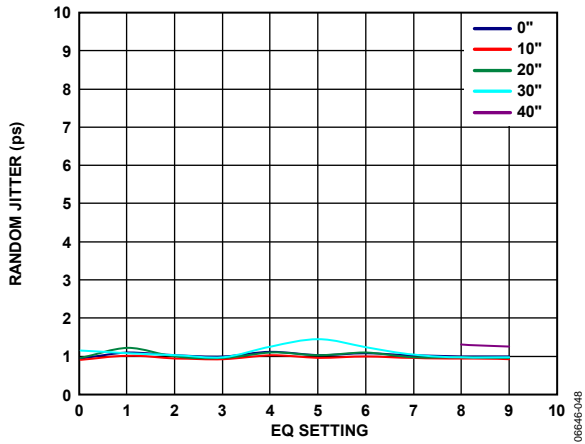

Figure 31. Random Jitter vs. EQ Setting vs. Trace

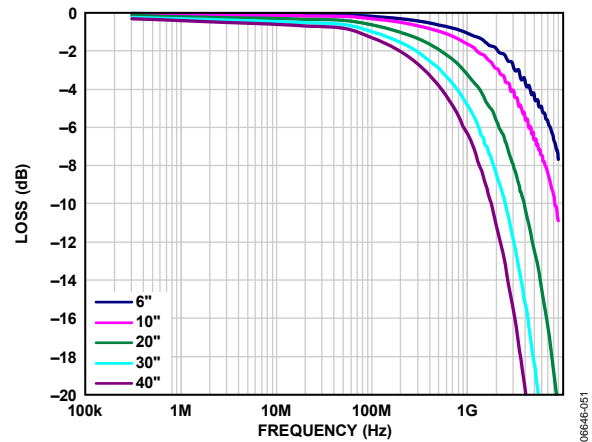

Figure 34. S21 Test Traces

THEORY OF OPERATION

The AD8158 is a buffered, asynchronous, three-port transceiver that allows 2:1 multiplexing and 1:2 demultiplexing among its ports. The 1:2 demux path supports bicast operation, allowing the AD8158 to operate as a port replicator as well as a redundancy switch. The AD8158 offers loopback on each lane, allowing the part to be configured as a 12-lane equalizer or redriver with FFE.

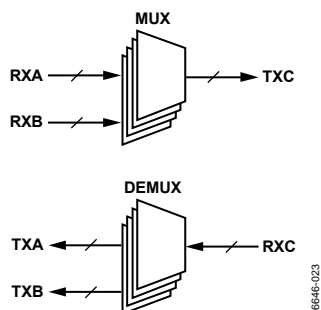

Figure 35. Mux/Demux Paths, Port A to Port C

The part offers extensively programmable transmit output levels and pre-emphasis settings as well as squelch or full-disable. The receivers integrate a programmable, multizero transfer function for aggressive equalization and a programmable loss-of-signal feature. The AD8158 provides a balanced, high speed switch core that maintains low lane-to-lane skew while preserving edge rates.

The I/O on-chip termination resistors are tied to user-settable supplies for increased flexibility. The AD8158 supports a wide primary supply range; V_{CC} can be set from 1.8 V to 3.3 V. These features, together with programmable transmitter output levels, allow for a wide range of dc- and ac-coupled I/O configurations.

The AD8158 supports several control and configuration modes, shown in Table 5.

Table 5. Control Modes

Mode	Description
Toggle Pin Control	Asynchronous control through toggle pins only
Mixed Control	Switch configuration via toggle pins, register-based control through the I ² C serial interface
Serial Control	Register-based control through the I ² C serial interface

The pin control mode offers access to a subset of the total feature list but allows for a much simplified control scheme. Table 6 compares the available features in all control modes.

The primary advantage of using the serial control interface is that it allows finer resolution in setting receive equalization, transmitter pre-emphasis, loss-of-signal (LOS) behavior, and output levels.

By default, the AD8158 starts in the pin control mode. Strobing the RESETb pin sets all on-chip registers to their default values and uses pins to configure switch connectivity, PE, and EQ levels. In mixed mode, switch connectivity is still controlled through the SEL[3:0], LB_[A:C], and BICAST pins. The user can override PE and EQ settings in mixed mode. In serial mode, all functions are accessed through registers and the control pin inputs are ignored, except RESETb. Register 0x0F selects the control mode (see Table 7).

The AD8158 register set is controlled through a 2-wire I²C interface. The AD8158 acts only as an I²C slave device. The 7-bit slave address for the AD8158 I²C interface contains the static value b1010 for the upper four bits. The lower three bits are controlled by the input pins I2C_A[2:0].

Table 6. Features Available Through Toggle Pin or Serial Control

Feature	Pin Control	Serial Control
Switch Features		
BICAST	One pin	One bit
A/B Lane Select	Four pins	Four bits
Loopback	Three pins	Three bits
Rx Features		
EQ Levels	Four settings	10 settings
N/P Swap	Not available	Available
Squelch	Enabled	Three bits
Tx Features		
Programmable Output Levels	± 400 mV diff fixed ¹	± 200 mV diff/ ± 300 mV diff/ ± 400 mV diff/ ± 600 mV diff
PE Levels	Two settings	>7 settings

¹ ± 400 mV diff indicates a 400 mV amplitude signal measured between two differential nodes. The voltage swing at differential I/O pins is described in this data sheet both in terms of the differentially measured voltage range (± 400 mV diff, for example) and in terms of peak-to-peak differential swing, denoted mV p-p diff. An output level setting of ± 400 mV diff delivers a differential peak-to-peak output voltage of 800 mV p-p diff.

AD8158

Table 7. Register Address 0x0F

Bit 7	Bit 6	Bit 5	Bit 4	Bit 3	Bit 2	Bit 1	Bit 0	Function
Set to 0	Set to 0	Set to 0	Set to 0	Set to 0	Set to 0	MODE[1]	MODE[0]	Mode

Table 8. Setting the Control Interface Mode

Mode 1	Mode 0	Control Mode
0	0	Pin control
0	1	Mixed control
1	1	Serial control

THE SWITCH (MUX/DEMUX/UNICAST/BICAST/LOOPBACK)

The mux and demux functions of the AD8158 can be controlled either with the toggle pins or through the register map. The multiplexer path switches received data from Input Port A or Input Port B to Output Port C. The SEL[3:0] pins allow switching lanes independently. The demultiplexer path switches received data from Input Port C to Output Port A, Output Port B, or (if bicast mode is enabled) to both Output Port A and Output Port B.

Table 9. Port Selection and Configuration with All Loopbacks Disabled

BICAST	SELx	Output Port A	Output Port B	Output Port C
0	0	Ix_C[3:0]	Idle	Ix_A[3:0]
0	1	Idle	Ix_C[3:0]	Ix_B[3:0]
1	0	Ix_C[3:0]	Ix_C[3:0]	Ix_A[3:0]
1	1	Ix_C[3:0]	Ix_C[3:0]	Ix_B[3:0]

When the device is in unicast mode, the output lanes on either Port A or Port B are in an idle state. In the idle state, the output tail current is set to 0, and the P and N sides of the lane are pulled up to the output termination voltage through the on-chip termination resistors. To save power, the unused receiver automatically disables.

The AD8158 supports port-level loopback, illustrated in Figure 36. The loopback control pins override the lane select (SEL[3:0]) and bicast control (BICAST) pin settings at the port level. In serial control mode, Bits [6:4] of Register 0x01 control loopback and are equivalent to asserting Pin LB_A, Pin LB_B, and Pin LB_C. Table 10 summarizes the different loopback configurations.

The loopback feature is useful for system debug, self test, and initialization, allowing system ASICs to compare Tx and Rx data sent over a single bidirectional link. Loopback can also be used to configure the device as a 4- to 12-lane receive equalizer or backplane redriver.

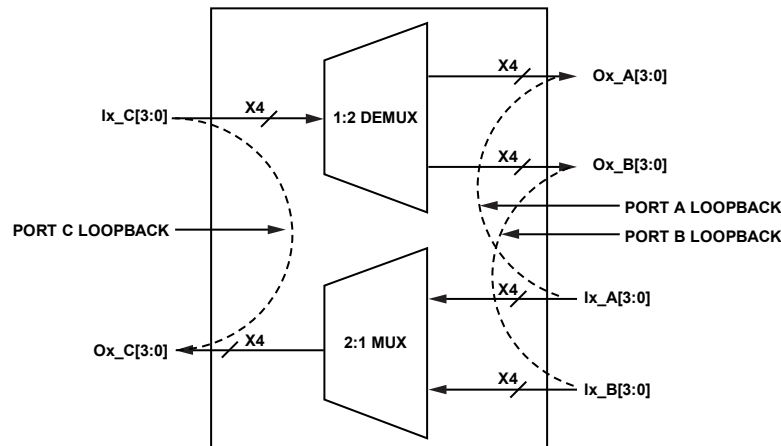

Figure 36. Port Level Loopback

08646-024

Table 10. Switch Connectivity vs. Loopback, BICAST, and Port Select Settings

LBA	LBB	LBC	BICAST	SELAb/B	Output Port A	Output Port B	Output Port C
0	0	0	0	0	Ix_C[3:0]	Idle	Ix_A[3:0]
0	0	0	0	1	Idle	Ix_C[3:0]	Ix_B[3:0]
0	0	0	1	0	Ix_C[3:0]	Ix_C[3:0]	Ix_A[3:0]
0	0	0	1	1	Ix_C[3:0]	Ix_C[3:0]	Ix_B[3:0]
0	0	1	0	0	Ix_C[3:0]	Idle	Ix_C[3:0]
0	0	1	0	1	Idle	Ix_C[3:0]	Ix_C[3:0]
0	0	1	1	0	Ix_C[3:0]	Ix_C[3:0]	Ix_C[3:0]
0	0	1	1	1	Ix_C[3:0]	Ix_C[3:0]	Ix_C[3:0]
0	1	0	0	0	Ix_C[3:0]	Ix_B[3:0]	Ix_A[3:0]
0	1	0	0	1	Idle	Ix_B[3:0]	Ix_B[3:0]
0	1	0	1	0	Ix_C[3:0]	Ix_B[3:0]	Ix_A[3:0]
0	1	0	1	1	Ix_C[3:0]	Ix_B[3:0]	Ix_B[3:0]
0	1	1	0	0	Ix_C[3:0]	Ix_B[3:0]	Ix_C[3:0]
0	1	1	0	1	Idle	Ix_B[3:0]	Ix_C[3:0]
0	1	1	1	0	Ix_C[3:0]	Ix_B[3:0]	Ix_C[3:0]
0	1	1	1	1	Ix_C[3:0]	Ix_B[3:0]	Ix_C[3:0]
1	0	0	0	0	Ix_A[3:0]	Idle	Ix_A[3:0]
1	0	0	0	1	Ix_A[3:0]	Ix_C[3:0]	Ix_B[3:0]
1	0	0	1	0	Ix_A[3:0]	Ix_C[3:0]	Ix_A[3:0]
1	0	0	1	1	Ix_A[3:0]	Ix_C[3:0]	Ix_B[3:0]
1	0	1	0	0	Ix_A[3:0]	Idle	Ix_C[3:0]
1	0	1	0	1	Ix_A[3:0]	Ix_C[3:0]	Ix_C[3:0]
1	0	1	1	0	Ix_A[3:0]	Ix_C[3:0]	Ix_C[3:0]
1	0	1	1	1	Ix_A[3:0]	Ix_C[3:0]	Ix_C[3:0]
1	1	0	0	0	Ix_A[3:0]	Ix_B[3:0]	Ix_A[3:0]
1	1	0	0	1	Ix_A[3:0]	Ix_B[3:0]	Ix_B[3:0]
1	1	0	1	0	Ix_A[3:0]	Ix_B[3:0]	Ix_A[3:0]
1	1	0	1	1	Ix_A[3:0]	Ix_B[3:0]	Ix_B[3:0]
1	1	1	0	0	Ix_A[3:0]	Ix_B[3:0]	Ix_C[3:0]
1	1	1	0	1	Ix_A[3:0]	Ix_B[3:0]	Ix_C[3:0]
1	1	1	1	0	Ix_A[3:0]	Ix_B[3:0]	Ix_C[3:0]
1	1	1	1	1	Ix_A[3:0]	Ix_B[3:0]	Ix_C[3:0]

RECEIVERS

The AD8158 receivers incorporate 50 Ω on-chip termination, ESD protection, and a multizero equalization function capable of delivering up to 18 dB of boost at 4.25 GHz. The AD8158 can compensate signal degradation at 6.5 Gbps from over 40 inches of FR-4 backplane trace. The receive path also incorporates a loss-of-signal (LOS) function with user programmable threshold and hysteresis, which squelches the associated transmitter when the midband differential voltage falls below a specified threshold value. Finally, the receivers implement a sign-swapping option (P/N swap), which allows the user to invert the sign of the input signal path and eliminates the need for board-level crossovers in the receive channels.

Input Structure and Allowed Input Levels

The AD8158 tolerates an input common-mode range (measured with zero differential input) of

$$V_{EE} + 0.6 \text{ V} < V_{IN_CM} < V_{CC} + 0.3 \text{ V}$$

Typical supply configurations include, but are not limited to, those listed in Table 11.

Table 11. Typical Input Supply Configurations

Configuration	DV _{CC}	V _{CC}	V _{TTI}
Low V _{TTI} , AC-Coupled Input	3.3 V – 1.8 V	1.8 V	1.6 V
Single 1.8 V Supply	3.3 V – 1.8 V	1.8 V	1.8 V
3.3 V Core	3.3 V	3.3 V	1.8 V
Single 3.3 V Supply	3.3 V	3.3 V	3.3 V

When dc-coupling with LVDS, CML, or ECL signals, it can be advantageous to operate with split or negative supplies (see the Applications Information section). In these applications, it is necessary to observe the maximum voltage ratings between V_{CC} and V_{EE} and generally to select supply voltages for V_{TTO} and V_{TTI} in the range of V_{CC} to V_{EE} to avoid activating the ESD protection devices.

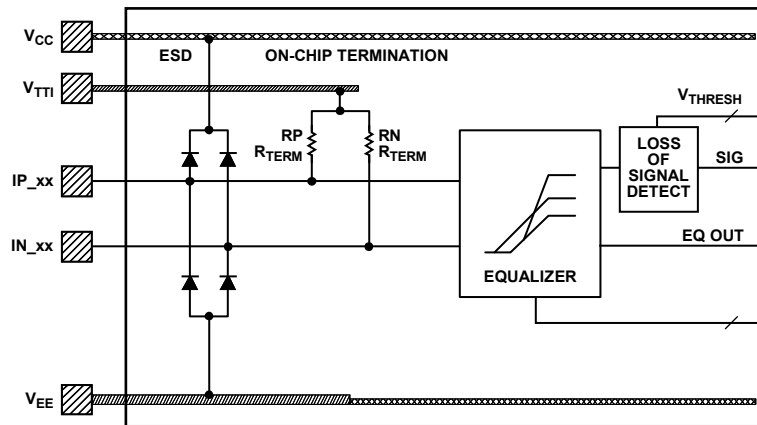

Figure 37. Functional Diagram of the AD8158 Receiver

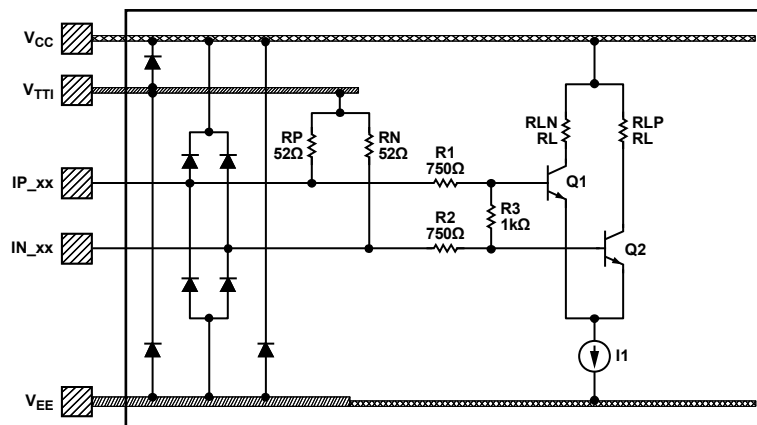

Figure 38. Simplified Receiver Input Structure

LANE DISABLES

By default, the receivers and transmitters enable in an on-demand fashion according to the state of the SEL[3:0], LB_[A:C], and BICAST pins or to the state of the equivalent registers in serial control mode. Register 0x40, Register 0x80, and Register 0xC0 implement per-lane disables for the receivers and Register 0x48, Register 0x88, and Register 0xC8 implement per-lane transmitter disables. These disables override the default settings. Each bit in the register is named for the lane and function it disables. For example, RXDIS B2 disables the receiver on Lane 2 of Port B while TXDIS C3 disables the Lane 3 transmitter of Port C (see Table 12).

EQUALIZER SETTINGS

Every input lane offers a low power, asynchronous, programmable receive equalizer for NRZ data up to 6.5 Gbps. The pin control interface makes four levels of receive equalization available: 6 dB, 12 dB, 15 dB, and 18 dB. Register-based control allows the user 10 equalizer settings within this range. High frequency boost increases monotonically (and approximately linearly) with EQ control setting in ~2 dB steps.

The four LSBs of Register 0x41, Register 0x81, and Register 0xC1 allow programming of all the equalizers in a port simultaneously (see Table 12). The 0x42, 0x43, 0x82, 0x83, 0xC2, and 0xC3 registers allow per-lane programming of the equalizers (see Table 23). Be aware that writing to the port-level equalizer registers updates and overwrites per-lane settings.

LOSS OF SIGNAL (LOS)

The serial control interface allows access to the AD8158 loss of signal features. (LOS is not available in pin control mode.) Each receiver includes a low power, loss-of-signal detector. The loss-of-signal circuit monitors the received data stream and generates a system interrupt when the received signal power falls below a programmed threshold. The default threshold is 25 mV diff, referred to the input pins. The LOS circuit monitors the equalized receive waveform and integrates the rms power of

the equalized waveform over a selectable interval of either 2 ns or 10 ns. The detectors are enabled on a per-port basis with Bit 0 of the RXA/B/C LOS control registers (0x51, 0x91, 0xD1).

By default, when the receiver detects an LOS event, it squelches its associated transmitter, lowering the output current to submicroamps. This prevents the high gain, wide bandwidth signal path from turning low-level system noise on an undriven input pair into a source of hostile crosstalk at the transmitter. The squelch feature can be disabled with Bit 3 of the global squelch control register (0x04).

Register 0x50, Register 0x90, and Register 0xD0 set values for the LOS signal detection threshold for Port A, Port B, and Port C, respectively. The recommended setting is Rx LOS threshold register = 0x10 with Rx LOS control register = 0x05. This is an optimum setting that all parts are factory tested to comply with (see Table 1).

LOS Recommended Settings

Rx LOS threshold register: 0x10

Rx LOS control register: 0x05

Register 0x51, Register 0x91, and Register 0xD1 set the integration interval, LOS gain, and the enable state for the LOS feature for Port A, Port B, and Port C, respectively (see Table 14 through Table 16)

Bit 0, LOS_ENB, enables and disables the LOS detectors. (The default setting is enabled, LOS_ENB = 1).

Bit 1, LOS_GSEL, adjusts the detector gain (1 = high gain, 0 = low gain). A value of 0 is recommended.

Bit 2, LOS_FILT, adjusts the interval over which incoming data is averaged. LOS_FILT = 0 gives a 2 ns interval and LOS_FILT = 1 sets a 10 ns interval.

Bit 7 through Bit 3 should be set to 0.

AD8158

Table 12. Per Lane Disables

Address	Bit 7	Bit 6	Bit 5	Bit 4	Bit 3	Bit 2	Bit 1	Bit 0	Function
0x40					RXDIS A3	RXDIS A2	RXDIS A1	RXDIS A0	RXA disable
0x80					RXDIS B3	RXDIS B2	RXDIS B1	RXDIS B0	RXB disable
0xC0					RXDIS C3	RXDIS C2	RXDIS C1	RXDIS C0	RXC disable
0x48					TXDIS A3	TXDIS A2	TXDIS A1	TXDIS A0	TXA disable
0x88					TXDIS B3	TXDIS B2	TXDIS B1	TXDIS B0	TXB disable
0xC8					TXDIS C3	TXDIS C2	TXDIS C1	TXDIS C0	TXC disable

Table 13. Port-Level EQ Setting

Address	Bit 7	Bit 6	Bit 5	Bit 4	Bit 3	Bit 2	Bit 1	Bit 0	Function
0x41					AEQ[3]	AEQ[2]	AEQ[1]	AEQ[0]	Port A equalizer
0x81					BEQ[3]	BEQ[2]	BEQ[1]	BEQ[0]	Port B equalizer
0xC1					CEQ[3]	CEQ[2]	CEQ[1]	CEQ[0]	Port C equalizer

Table 14. Global Loss-of-Signal Squelch Control Register

Address	Bit 7	Bit 6	Bit 5	Bit 4	Bit 3	Bit 2	Bit 1	Bit 0	Function
0x04					GSQLCH_ENB				Global squelch control

Table 15. Port-Level Loss-of-Signal Control Registers

Address	Bit 7	Bit 6	Bit 5	Bit 4	Bit 3	Bit 2	Bit 1	Bit 0	Function
0x50	Set to 0	Set to 0	THRBIT[5]	THRBIT[4]	THRBIT[3]	THRBIT[2]	THRBIT[1]	THRBIT[0]	RXA LOS threshold
0x51	Set to 0	Set to 0	Set to 0	Set to 0	Set to 0	LOS_FILT	LOS_GSEL	LOS_ENB	RXA LOS control
0x90	Set to 0	Set to 0	THRBIT[5]	THRBIT[4]	THRBIT[3]	THRBIT[2]	THRBIT[1]	THRBIT[0]	RXB LOS threshold
0x91	Set to 0	Set to 0	Set to 0	Set to 0	Set to 0	LOS_FILT	LOS_GSEL	LOS_ENB	RXB LOS control
0xD0	Set to 0	Set to 0	THRBIT[5]	THRBIT[4]	THRBIT[3]	THRBIT[2]	THRBIT[1]	THRBIT[0]	RXC LOS threshold
0xD1	Set to 0	Set to 0	Set to 0	Set to 0	Set to 0	LOS_FILT	LOS_GSEL	LOS_ENB	RXC LOS control

Table 16. Loss-of-Signal Configuration Bits

Bit(s)	Function	Description	Default
THRBIT[5:0]	LOS threshold	Binary coded value between 0 and 31. Covers ranges of 10 mV to 60 mV and 60 mV to 250 mV for LOS_GSEL = 0 and LOS_GSEL = 1, respectively. Recommended setting = 0x10.	0x1C $V_{IN_DC} < 50$ mV
LOS_FILT	LOS filter	Loss-of-signal filter. 0: LOS integrates 2 ns of data. 1: LOS integrates 10 ns of data.	1
LOS_GSEL	LOS sensitivity	LOS gain select. Recommended setting = 0. 0: LOS covers an input range of 60 mV to 250 mV. 1: LOS covers an input range of 10 mV to 60 mV.	1
LOS_ENB	LOS enable	LOS enable. 0: LOS function disabled 1: LOS function enabled	1

The LOS_INT pin evaluates a logical OR of all LOS status register bits for all enabled receivers. (LOS status registers are located at 0x45, 0x85, and 0xC5.) The upper four bits in the RXA, RXB, and RXC LOS status registers are sticky while the four LSBs are continuously updated to indicate the instantaneous status of LOS for an enabled receiver. The sticky bits are cleared by writing 0 to the RXA, RXB, and RXC LOS status registers. The LOS_INT pin remains high after an LOS event until all sticky registers are cleared and all active status registers (for example, Bits [3:0]) read 0.

The LOS_INT pin can be used to generate an interrupt for the system control software. In a standard implementation, when LOS_INT goes high, the system software registers the interrupt and polls the RXA, RXB, and RXC LOS status registers to determine which input lost signal and if the signal has been restored.

LANE INVERSION: P/N SWAP

The receiver P/N swap function is a convenience intended to allow the user to implement the equivalent of a board-level routing crossover in a much smaller area while eliminating vias (impedance discontinuities) that compromise the high frequency integrity of the signal path.

A Note of Caution

Using this feature to correct an inversion downstream of the receiver may require the user to be aware of the sign of the data when switching connectivity (the mux/demux path). The feature is available on a per-lane setting through Register 0x44, Register 0x84, and Register 0xC4. Setting the bit true flips the sign sense of the P and N inputs for the associated lane. The default setting is 0 (no inversion).

TRANSMITTERS

The AD8158 transmitter offers programmable pre-emphasis, programmable output levels, output disable, and transmit squelch. The SEL4G pin lets the user lower the transmitter frequency of maximum boost from 3.25 GHz to 2.0 GHz,

allowing the AD8158 to offer exceptional transmit channel compensation for legacy applications (4.5 Gbps and slower).

OUTPUT LEVEL PROGRAMMING AND OUTPUT STRUCTURE

The output level of the transmitter of each lane is independently programmable. In pin control mode, a default output amplitude of 800 mV p-p diff (± 400 mV diff) is delivered (see Table 17). Register-based control allows the user to set the transmitter output levels on a per-port or per-lane basis to four predefined levels. Port-level programming overwrites lane-level configuration. The ALEV, BLEV, and CLEV bits in Register 0x49, Register 0x89, and Register 0xC9, respectively, are used to set the output levels for all transmitters. The A[3:0]OLEV[1:0], B[3:0]OLEV[1:0], and C[3:0]OLEV[1:0] bits in Register 0x4C, Register 0x8C, and Register 0xCC allow per-lane settings (see Table 23).

Table 17. Predefined Output Levels

[A/B/C]OLEV1	[A/B/C]OLEV0	Output Level
0	0	± 200 mV diff
0	1	± 300 mV diff
1	0	± 400 mV diff (default)
1	1	± 600 mV diff

Note that the choice of output level influences the output common-mode level. A 600 mV diff output level with a full PE range requires a supply and output termination voltage of 2.5 V or higher (V_{TTO} , $V_{CC} \geq 2.5$ V).

PRE-EMPHASIS

Transmitter pre-emphasis levels can be set by pin control or through the control registers. Pin control allows two settings of PE, 0 dB, and 6 dB. The control registers provide seven levels of PE. Note that a larger range of boost settings is available for lower output levels.

Pre-emphasis can be programmed per-port or per-lane. Register 0x49, Register 0x89, and Register 0xC9 set all outputs in a port at once. Registers 0x4A, 0x4B, 0x8A, 0x8B, 0xCA, and 0xCB allow setting PE on a per-lane basis.

Table 18. Lane Inversion Bits

Address	Bit 7	Bit 6	Bit 5	Bit 4	Bit 3	Bit 2	Bit 1	Bit 0	Function
0x44					PNA3	PNA2	PNA1	PNA0	P/N Swap A
0x84					PNB3	PNB2	PNB1	PNB0	P/N Swap B
0xC4					PNC3	PNC2	PNC1	PNC0	P/N Swap C

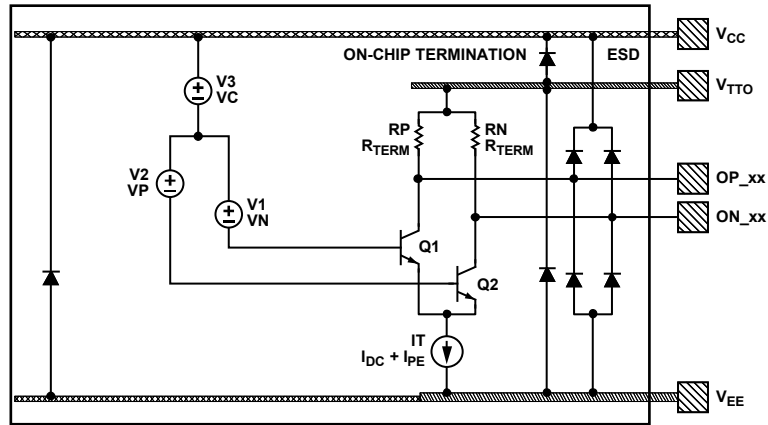

Figure 39. Simplified Transmitter Structure

Table 19. Setting Transmitter Pre-Emphasis (Note that Toggle Pin Control of PE Is Limited to the 400 mV diff Output Level Settings.)

Output Level (mV diff)	Pin PE_[A/B/C]	Bit [A/B/C][3:0]PE[2]	Bit [A/B/C][3:0]PE[1]	Bit [A/B/C][3:0]PE[0]	PE Boost (%)	PE Boost (dB)
200	N/A	0	0	0	0	0
200	N/A	0	0	1	50	3.52
200	N/A	0	1	0	100	6.02
200	N/A	0	1	1	150	7.96
200	N/A	1	0	0	200	9.54
200	N/A	1	0	1	250	10.88
200	N/A	1	1	0	300	12.04
300	N/A	0	0	0	0	0
300	N/A	0	0	1	33	2.5
300	N/A	0	1	0	67	4.44
300	N/A	0	1	1	100	6.02
300	N/A	1	0	0	133	7.36
300	N/A	1	0	1	167	8.52
300	N/A	1	1	0	200	9.54
400	0	0	0	0	0	0
400	N/A	0	0	1	25	1.94
400	N/A	0	1	0	50	3.52
400	N/A	0	1	1	75	4.86
400	1	1	0	0	100	6.02
400	N/A	1	0	1	125	7.04
400	N/A	1	1	0	150	7.96
600	N/A	0	0	0	0	0
600	N/A	0	0	1	17	1.34
600	N/A	0	1	0	33	2.5
600	N/A	0	1	1	50	3.52
600	N/A	1	0	0	67	4.44
600	N/A	1	0	1	83	5.26
600	N/A	1	1	0	100	6.02

OUTPUT COMPLIANCE, AC vs. DC COUPLING, MINIMUM SUPPLY VOLTAGE, AND THE TX_HEADROOM BIT

In low voltage applications, users must pay careful attention to both the differential and common-mode signal level. The choice of output voltage swing, pre-emphasis setting, supply voltages (V_{CC} and V_{TTO}), and output coupling (ac or dc) affect peak and settled single-ended voltage swings and the common-mode shift measured across the output termination resistors. These choices also affect output current and, consequently, power consumption.

Table 20 shows the change in output common-mode ($dV_{OCM} = V_{CC} - V_{OCM}$) with output level (V_{OD}) and pre-emphasis setting. Table 20 also shows the minimum and maximum dc and peak single-ended output levels (V_L , V_H , V_L peak, and V_H peak, respectively). The single-ended output levels are calculated for V_{TTO} supplies of 3.3 V and 1.8 V to illustrate practical challenges of reducing the supply voltage. Table 20 shows the voltage margins required for proper transmitter operation. Minimum V_L (min V_L) is the lowest single-ended voltage allowed given the user's choice of V_{CC} voltage.

For output levels greater than 400 mV diff (800 mV p-p diff), or when enabling the TX_HEADROOM bit, operating the part from core supply voltage, $V_{CC} \geq 2.5$ V, is suggested. In this high current case, setting the TX_HEADROOM bit to 1 allows the transmitter an extra 200 mV of output compliance range. Additional transmitter headroom is enabled on a per-port basis through Bits [6:4] in Register 0x05. A value of 0 disables the headroom generating circuitry; a value of 1 enables it.

Examples

Consider a typical application using pin control mode. In this case, the default output level of 400 mV diff (800 mV p-p diff) is selected and the user can choose pre-emphasis settings of 0 dB or 6 dB. Table 19 shows that with pre-emphasis disabled, a dc-coupled transmitter causes a 200 mV common-mode shift across the termination resistors whereas an ac-coupled transmitter causes twice the common-mode shift. Notice that with V_{CC} and V_{TTO} powered from a 1.8 V supply, the single-ended output voltage swings between 1.8 V and 1.4 V when dc-coupled and between 1.6 V and 1.2 V when ac-coupled. (Note also that $V_H = V_H$ peak and $V_L = V_L$ peak because transmitter pre-emphasis is disabled.) In both cases, these levels are greater than the minimum V_L limit of 725 mV, and V_{CC} satisfies the minimum V_{CC} limit of 1.8 V with the TX_HEADROOM bit set to 0. Note that setting TX_HEADROOM = 1 violates the minimum V_{CC} limit of 2.5 V.

With a PE setting of 6.02 dB, the ac-coupled transmitter has single-ended swings from 1.4 V to 0.6 V while the dc-coupled transmitter outputs swing between 1.8 V and 1 V. The peak minimum single-ended swing (V_L peak) of the ac-coupled transmitter, in this case, exceeds the minimum V_L limit of 725 mV by 125 mV. While objectionable in theory, in practice, this setting works quite well. The transmitter theoretical peak voltage is rarely achieved in practice because the high frequency characteristic of the pre-emphasis is attenuated at the output pins by the low-pass nature of the PC board environment and the channel. For 6.5 Gbps PE (SEL4G = 0), a 30% reduction of overshoot is not unexpected. For an output level of 400 mV diff and a PE setting of 6 dB, the user can calculate a maximum overshoot of 400 mV diff but can measure only a 270 mV overshoot.

Theory (maximum)

$$V_{overshoot_max} = V_{OD} \times (PE [V/V] - 1)$$

Measured

$$V_{overshoot_measured} = V_{OD} \times (PE [V/V] - 1) \times (1 - 0.3)$$

With the pre-emphasis configured for 4.25 Gbps operation (SEL4G = 1), the overshoot can only be reduced 5% from the theoretic maximum. In this case, the peak minimum voltage limit should be more closely observed.

SIGNAL LEVELS AND COMMON-MODE SHIFT FOR AC-COUPLED AND DC-COUPLED OUTPUTS

Table 20. Output Voltage Range and Output Common-Mode Shift vs. Output Level and PE Setting

Output Levels and Output Compliance					AC-Coupled Transmitter						DC-Coupled Transmitter					TX_HEADROOM = 0	TX_HEADROOM = 1
V _{OD} (mV)	I _{TOT} (mA)	I _{PRED} (mA)	V _{D_PEAK} (mV)	PE Boost	PE (dB)	dV _{OCM} (mV)	V _H (V)	V _L (V)	V _H Peak (V)	V _L Peak (V)	dV _{OCM} (mV)	V _H (V)	V _L (V)	V _H Peak (V)	V _L Peak (V)	Min V _L (V)	Min V _L (V)
V _{TTO} and V _{CC} = 3.3 V																	
200	8	29	200	1.00	0.00	200	3.2	3	3.2	3	100	3.3	3.1	3.3	3.1	2.2	2
200	12	48	300	1.50	3.52	300	3.1	2.9	3.15	2.85	150	3.25	3.05	3.3	3	2.2	2
200	16	48	400	2.00	6.02	400	3	2.8	3.1	2.7	200	3.2	3	3.3	2.9	2.2	2
200	20	48	500	2.50	7.96	500	2.9	2.7	3.05	2.55	250	3.15	2.95	3.3	2.8	2.2	2
200	24	48	600	3.00	9.54	600	2.8	2.6	3	2.4	300	3.1	2.9	3.3	2.7	2.2	2
200	28	51	700	3.50	10.88	700	2.7	2.5	2.95	2.25	350	3.05	2.85	3.3	2.6	2.2	2
200	32	51	800	4.00	12.04	800	2.6	2.4	2.9	2.1	400	3	2.8	3.3	2.5	2.2	2
300	12	29	300	1.00	0.00	300	3.15	2.85	3.15	2.85	150	3.3	3	3.3	3	2.2	2
300	16	48	400	1.33	2.50	400	3.05	2.75	3.1	2.7	200	3.25	2.95	3.3	2.9	2.2	2
300	20	48	500	1.67	4.44	500	2.95	2.65	3.05	2.55	250	3.2	2.9	3.3	2.8	2.2	2
300	24	48	600	2.00	6.02	600	2.85	2.55	3	2.4	300	3.15	2.85	3.3	2.7	2.2	2
300	28	48	700	2.33	7.36	700	2.75	2.45	2.95	2.25	350	3.1	2.8	3.3	2.6	2.2	2
300	32	51	800	2.67	8.52	800 ¹	2.65 ¹	2.35 ¹	2.9 ¹	2.1 ¹	400	3.05	2.75	3.3	2.5	2.2	2
300	36	51	900	3.00	9.54	900 ¹	2.55 ¹	2.25 ¹	2.85 ¹	1.95 ¹	450	3	2.7	3.3	2.4	2.2	2
400	16	29	400	1.00	0.00	400	3.1	2.7	3.1	2.7	200	3.3	2.9	3.3	2.9	2.2	2
400	20	48	500	1.25	1.94	500	3	2.6	3.05	2.55	250	3.25	2.85	3.3	2.8	2.2	2
400	24	48	600	1.50	3.52	600	2.9	2.5	3	2.4	300	3.2	2.8	3.3	2.7	2.2	2
400	28	48	700	1.75	4.86	700	2.8	2.4	2.95	2.25	350	3.15	2.75	3.3	2.6	2.2	2
400	32	48	800	2.00	6.02	800 ¹	2.7 ¹	2.3 ¹	2.9 ¹	2.1 ¹	400	3.1	2.7	3.3	2.5	2.2	2
400	36	51	900	2.25	7.04	900 ¹	2.6 ¹	2.2 ¹	2.85 ¹	1.95 ¹	450	3.05	2.65	3.3	2.4	2.2	2
400	40	51	1000	2.50	7.96						500	3	2.6	3.3	2.3	2.2	2
600	24	32	600	1.00	0.00	600	3	2.4	3	2.4	300	3.3	2.7	3.3	2.7	2.2	2
600	28	51	700	1.17	1.34	700	2.9	2.3	2.95	2.25	350	3.25	2.65	3.3	2.6	2.2	2
600	32	51	800	1.33	2.50	800 ¹	2.8 ¹	2.2 ¹	2.9 ¹	2.1 ¹	400	3.2	2.6	3.3	2.5	2.2	2
600	36	51	900	1.50	3.52	900 ¹	2.7 ¹	2.1 ¹	2.85 ¹	1.95 ¹	450	3.15	2.55	3.3	2.4	2.2	2
600	40	51	1000	1.67	4.44						500	3.1	2.5	3.3	2.3	2.2	2
600	44	54	1100	1.83	5.26						550	3.05	2.45	3.3	2.2	2.2	2
600	48	54	1200	2.00	6.02						600 ¹	3 ¹	2.4 ¹	3.3 ¹	2.1 ¹	2.2	2
V _{CC} and V _{TTO} = 1.8 V, TX_HEADROOM = 1 requires V _{CC} > 2.5 V																	
200	8	29	200	1.00	0.00	200	1.7	1.5	1.7	1.5	100	1.8	1.6	1.8	1.6	0.7	0.5
200	12	48	300	1.50	3.52	300	1.6	1.4	1.65	1.35	150	1.75	1.55	1.8	1.5	0.7	0.5
200	16	48	400	2.00	6.02	400	1.5	1.3	1.6	1.2	200	1.7	1.5	1.8	1.4	0.7	0.5
200	20	48	500	2.50	7.96	500	1.4	1.2	1.55	1.05	250	1.65	1.45	1.8	1.3	0.7	0.5
200	24	48	600	3.00	9.54	600	1.3	1.1	1.5	0.9	300	1.6	1.4	1.8	1.2	0.7	0.5
200	28	51	700	3.50	10.88	700	1.2	1	1.45	0.75	350	1.55	1.35	1.8	1.1	0.7	0.5
200	32	51	800	4.00	12.04						400	1.5	1.3	1.8	1	0.7	0.5
300	12	29	300	1.00	0.00	300	1.65	1.35	1.65	1.35	150	1.8	1.5	1.8	1.5	0.7	0.5
300	16	48	400	1.33	2.50	400	1.55	1.25	1.6	1.2	200	1.75	1.45	1.8	1.4	0.7	0.5
300	20	48	500	1.67	4.44	500	1.45	1.15	1.55	1.05	250	1.7	1.4	1.8	1.3	0.7	0.5
300	24	48	600	2.00	6.02	600	1.35	1.05	1.5	0.9	300	1.65	1.35	1.8	1.2	0.7	0.5
300	28	48	700	2.33	7.36	700	1.25	0.95	1.45	0.75	350	1.6	1.3	1.8	1.1	0.7	0.5
300	32	51	800	2.67	8.52						400	1.55	1.25	1.8	1	0.7	0.5
300	36	51	900	3.00	9.54						450	1.5	1.2	1.8	0.9	0.7	0.5
400	16	29	400	1.00	0.00	400	1.6	1.2	1.6	1.2	200	1.8	1.4	1.8	1.4	0.7	0.5
400	20	48	500	1.25	1.94	500	1.5	1.1	1.55	1.05	250	1.75	1.35	1.8	1.3	0.7	0.5
400	24	48	600	1.50	3.52	600	1.4	1	1.5	0.9	300	1.7	1.3	1.8	1.2	0.7	0.5
400	28	48	700	1.75	4.86	700	1.3	0.9	1.45	0.75	350	1.65	1.25	1.8	1.1	0.7	0.5
400	32	48	800	2.00	6.02						400	1.6	1.2	1.8	1	0.7	0.5
400	36	51	900	2.25	7.04						450	1.55	1.15	1.8	0.9	0.7	0.5
400	40	51	1000	2.50	7.96						500	1.5	1.1	1.8	0.8	0.7	0.5

Output Levels and Output Compliance						AC-Coupled Transmitter					DC-Coupled Transmitter					TX_HEADROOM = 0	TX_HEADROOM = 1
V _{OD} (mV)	I _{TOT} (mA)	I _{PRED} (mA)	V _{D_PEAK} (mV)	PE Boost	PE (dB)	dV _{OCM} (mV)	V _H (V)	V _L (V)	V _H Peak (V)	V _L Peak (V)	dV _{OCM} (mV)	V _H (V)	V _L (V)	V _H Peak (V)	V _L Peak (V)	Min V _L (V)	Min V _L (V)
600	24	32	600	1.00	0.00	600	1.5	0.9	1.5	0.9	300	1.8	1.2	1.8	1.2	0.7	0.5
600	28	51	700	1.17	1.34	700	1.4	0.8	1.45	0.75	350	1.75	1.15	1.8	1.1	0.7	0.5
600	32	51	800	1.33	2.50						400	1.7	1.1	1.8	1	0.7	0.5
600	36	51	900	1.50	3.52						450	1.65	1.05	1.8	0.9	0.7	0.5
600	40	51	1000	1.67	4.44						500	1.6	1	1.8	0.8	0.7	0.5
600	44	54	1100	1.83	5.26						550	1.55	0.95	1.8	0.7	0.7	0.5
600	48	54	1200	2.00	6.02										0.7	0.7	0.5

¹ Requires TX_HEADROOM = 1.

Table 21. Symbol Definitions

Symbol	Formula	Definition
V _{OD}	$25 \Omega \times I_{DC}$	Peak differential output voltage
V _{OD} p-p	$25 \Omega \times I_{DC} \times 2 = 2 \times V_{OD}$	Peak-to-peak differential output voltage
$\Delta V_{OCM_DC-COUPLED}$	$25 \Omega \times I_{TX}/2 = V_{ODPP}/4 + (I_{PE}/2 \times 25)$	Output common-mode shift
$\Delta V_{OCM_AC-COUPLED}$	$50 \Omega \times I_{TX}/2 = V_{ODPP}/2 + (I_{PE}/2 \times 50)$	Output common-mode shift
I _{DC}	V_{OD}/R_{TERM}	Output current that sets output level
I _{PE}	N/A	Output current used for PE
I _{TX}	$I_{DC} + I_{PE}$	Total transmitter output current
V _H	$V_{TTO} - \Delta V_{OCM} + V_{OD}/2$	Maximum single-ended output voltage
V _L	$V_{TTO} - \Delta V_{OCM} - V_{OD}/2$	Minimum single-ended output voltage

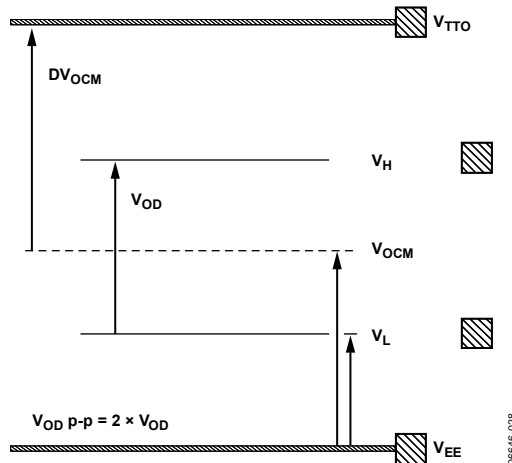

Figure 40. V_H, V_L, V_{OCM}

08646-028

AD8158

SQUELCH AND DISABLE

Each transmitter is equipped with disable and squelch controls. Disable is a full power-down state: the transmitter current is reduced to zero and the output pins pull up to V_{TTO} , but there is a delay of approximately 1 μ s associated with re-enabling the transmitter. Squelch simply reduces the output current to submicroamp levels, again allowing both output pins to pull up to V_{TTO} through the output termination resistors. The transmitter recovers from squelch in less than 100 ns.

SPEED SELECT

The SEL4G pin lets the user lower the transmitter frequency of maximum boost from 3.25 GHz to 2.0 GHz, allowing the AD8158 to offer exceptional transmit channel compensation for legacy applications (4.5 Gbps and slower). SEL4G = 1 lowers the frequency of maximum boost without sacrificing the amount of boost delivered.

AD8158 POWER CONSUMPTION

There are several sections of the AD8158 that draw varying power depending on the supply voltages, the type of I/O coupling used, and the status of the AD8158 operation. Figure 41 shows a block diagram of these sections. Figure 42 summarizes the power consumption of each section and is a useful guide as the following sections are reviewed.

A power budget calculator is available on the AD8158 product page at www.analog.com.

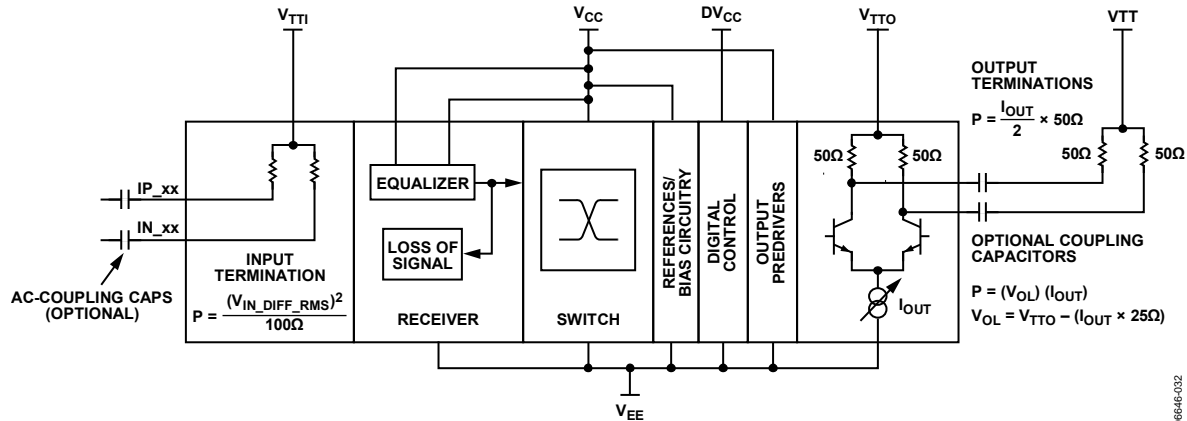

Figure 41. AD8158 Power Distribution Block Diagram

06646-032

Power Budget Calculator	Input Term. Resistors	RX EQ	RX LOS	Core	Output Pre-driver: I _{PRE} [mA]	Output Switch Current Source: I _{OT} [mA]	Output Term. Resistors, AC-Coupled	Off-Chip Termination Resistors, AC-Coupled	Output Term. Resistors, DC-Coupled	Off-Chip Termination Resistors, DC-Coupled	Driver Power AC-Coupled	Driver Power DC-Coupled	References	Digital Control	Total Power AC-Coupled Output	Total Power DC-Coupled Output
Power Budget Calculator																
Quiescent Current	V _{IN} /R _{TERM}			2 mA												
Current per Active Channel for Differential	566 mV rms/100 = 5.66 mA (PE = 0 dB)	14.4 mA	4 mA	4.6 mA	I _{PRE} = 29 mA	I _{OT} = 16 mA	V _{OD} /50 = 8 mA	V _{OD} /50 = 8 mA	V _{OD} _PEAK/25 = 16 mA				162 mA	1.6 mA		
Current per Active Channel for Differential	566 mV rms/100 = 5.66 mA	14.4 mA	4 mA	4.6 mA	48 mA	32 mA	8 mA	8 mA	16 mA							
Sine V _{OUT} = 800 mV p-p (PE = 0 dB)																
1.8 V Operation (V _{CC} - V _{EE} = 1.8 V, V _{TR0} = 1.8 V, V _{OUT} = 800 mV p-p diff)																
Per-Channel Power, Ch A and Ch B, PE = 0 dB	3.2 mW	26 mW	7.2 mW	8.3 mW	52.2 mW	See driver power	3.2 mW	3.2 mW	See driver power	3.2 mW	25.6 mW	25.6 mW				
Per-Channel Power, Ch C, PE = 6 dB	3.2 mW	26 mW	7.2 mW	8.3 mW	86.4 mW	See driver power	3.2 mW	3.2 mW	See driver power	4.8 mW	57.6 mW	52.8 mW				
Power with All Channels Active (Bicast and LB off, PE _A = 0 dB, PE _C = 6 dB, DVCC = 3.3 V)	25.6 mW	208 mW	58 mW	70 mW	555 mW	See driver power	25.6 mW	25.6 mW	See driver power	32 mW	333 mW	314 mW	292 mW	5.3 mW	1547 mW	1528 mW
% of Total On-Chip Power (AC)	1.70%	13%	3.70%	4.50%	35.90%	See driver power	0%	0%	0%	0%	21.50%	21.50%	18.90%	0.30%	100%	99%
Power with All Channels Active (Loopback Enabled, PE _A = PE _B = 0 dB, PE _C = 6 dB, DVCC = 3.3 V)	25.6 mW	311 mW	87 mW	103 mW	763 mW	See driver power	38.4 mW	38.4 mW	See driver power	44.8 mW	435 mW	416 mW	292 mW	5.3 mW	2022 mW	2003 mW
% of Total On-Chip Power (AC)	1.30%	15.40%	4.30%	5.10%	37.70%	See driver power	0%	0%	0%	0%	21.50%	21.50%	14.40%	0.30%	100%	99%
3.3 V Operation (V _{CC} - V _{EE} = 3.3 V, V _{TR0} = 3.3 V, V _{OUT} = 800 mV p-p diff)																
Per-Channel Power, Ch A and Ch B, PE = 0 dB	3.2 mW	47.5 mW	13 mW	15.2 mW	96 mW	See driver power	3.2 mW	3.2 mW	See driver power	3.2 mW	52.8 mW	49.6 mW				
Per-Channel Power, Ch C, PE = 6 dB	3.2 mW	47.5 mW	13 mW	15.2 mW	158 mW	See driver power	3.2 mW	3.2 mW	See driver power	4.8 mW	105.6 mW	100.8 mW				
Power with All Channels Active (Loopback Enabled, PE _A = PE _B = 0 dB, PE _C = 6 dB, DVCC = 3.3 V)	0.90%	13.40%	3.70%	4.50%	1016 mW	See driver power	25.6 mW	25.6 mW	0%	0%	22.40%	602 mW	535 mW	5.3 mW	2830 mW	2798 mW
% of Total On-Chip Power (AC)	0.90%	13.40%	3.70%	4.50%	35.90%	See driver power	0%	0%	0%	0%	22.40%	22.40%	18.90%	0.20%	100%	99%
Power with All Channels Active (Loopback Enabled, PE _A = PE _B = 0 dB, PE _C = 6 dB, DVCC = 3.3 V)	25.6 mW	570 mW	158 mW	189 mW	1400 mW	See driver power	38.4 mW	38.4 mW	See driver power	44.8 mW	845 mW	800 mW	535 mW	5.3 mW	3728 mW	3682 mW
% of Total On-Chip Power (AC)	0.70%	15.30%	4.20%	5.10%	37.60%	See driver power	0%	0%	0%	0%	22.70%	22.70%	14.40%	0.10%	100%	99%
Power with All Channels Active (Loopback Enabled, PE _A = PE _B = PE _C = 6 dB, DVCC = 3.3 V)	25.6 mW	570 mW	158 mW	189 mW	1896 mW	See driver power	38.4 mW	38.4 mW	See driver power	57.6 mW	1267 mW	1210 mW	535 mW	5.3 mW	4646 mW	4589 mW
% of Total On-Chip Power (AC)	0.60%	12.30%	3.40%	4.10%	40.80%	See driver power	0%	0%	0%	0%	27.30%	27.30%	11.50%	0.10%	100%	99%

Figure 42. Power Budget Calculator
Rev. 0 | Page 27 of 36

The first section is the input termination resistors. The power dissipated in the termination resistors is due to the input differential swing and any common-mode current resulting from dc-coupling the input.

In the next section, the receiver, each input is powered only when it is selected and the disable bits are set to 0. If a receiver is not selected, it is powered down. Thus, the total number of active inputs affects the total power consumption. Furthermore, the loss-of-signal detection circuits can be disabled independent of the receiver for even greater power savings.

The core of the device performs the multiplexer and demultiplexer switching functions. It draws a fixed quiescent current of 2 mA whenever the AD8158 is powered from V_{CC} to V_{EE} . The switch draws an additional 8×4.6 mA in normal mux/demux operation and an additional 12×4.6 mA with all ports in loopback or with bicast selected. The switch core can be disabled to save power.

An output predriver section draws a current, I_{PRED} , that is related to the programmed output current, I_{TOT} . Table 20 lists values for I_{TOT} and I_{PRED} for all settings of output level and pre-emphasis. The predriver current always flows from V_{CC} to V_{EE} . It is treated separately from the output current, which flows from V_{TTO} , and may not be the same voltage as V_{CC} .

The final section is the outputs. For an individual output, the programmed output current flows through two separate paths. One is the on-chip termination resistor, and the other is the transmission line and the destination termination resistor. The nominal parallel impedance of these two paths is 25 Ω . The sum of these two currents flows through the switches and the current source of the AD8158 output circuit and out through V_{EE} . The power dissipated in the transmission line and the destination resistor is not dissipated in the AD8158 but has to be supplied from the power supply and is a factor in the overall system power. The current in the on-chip termination resistors and the output current source dissipate power in the AD8158 itself.

OUTPUTS

The output current is set by a combination of output level and pre-emphasis setting (see Table 20). For the two logic switch states, this current flows through an on-chip termination resistor and a parallel path to the destination device and its termination resistor. The power in this parallel path is not dissipated by the AD8158. With pre-emphasis enabled, some current always flows in both the P and N termination resistors.

This pre-emphasis current gives rise to an output common-mode shift, which varies with ac-coupling or dc-coupling and which is calculated for both cases in Table 20.

Perhaps the most direct method for calculating power dissipated in the output is to calculate the power that would be dissipated if all of I_{TOT} were to flow on-die from V_{TTO} to V_{EE} and to subtract from this the power dissipated off-die in the destination device termination resistors and the channel. For this purpose, the destination device and channel can be modeled as 50 Ω load resistors, R_L , in parallel with the AD8158 termination resistors.

POWER SAVING CONSIDERATIONS

While the AD8158 power consumption is very low compared to similar devices, careful control of its operating conditions can yield further power savings. Significant power reduction can be realized by operating the part at a lower voltage. Compared to 3.3 V operation, a supply voltage of 1.8 V can result in power savings of ~45%. There is no performance penalty when operating at lower voltage.

A second measure is to disable transmitters when they are not being used. This can be done on a static basis if the output is not used or on a dynamic basis if the output does not have a constant stream of traffic. On transmit disable (Register 0x48, Register 0x88, Register 0xC8), both the predriver and output switch currents are disabled. The LOS-activated squelch disables only the output switch current, I_{TOT} . Superior power saving is achieved by using the TX and RX disable registers to turn off an unused lane as opposed to relying on the AD8158 transmit squelch feature.

Because the majority of the power dissipated is in the output stage, some of its flexibility can be used to lower the power consumption. First, the output current and output pre-emphasis settings can be programmed to the smallest amount required to maintain BER performance. If an output circuit always has a short length and the receiver has good sensitivity, then a lower output current can be used.

It is also possible to lower the voltage on V_{TTO} to lower the power dissipation. The amount that V_{TTO} can be lowered is dependent on the lowest of all the output's V_{OL} and V_{CC} . This is determined by the output that is operating at the highest programmed output current. Table 1 and Table 20 list minimum output levels.

I²C CONTROL INTERFACE

SERIAL INTERFACE GENERAL FUNCTIONALITY

The AD8158 register set is controlled through a 2-wire I²C interface. The AD8158 acts only as an I²C slave device. The 7-bit slave address for the AD8158 I²C interface contains the static value b1010 for the upper four bits. The lower three bits are controlled by the input pins I2C_A[2:0].

Therefore, the I²C bus in the system needs to include an I²C master to configure the AD8158 and other I²C devices that may be on the bus. Data transfers are controlled through the use of the two I²C wires: the SCL input clock pin and the SDA bidirectional data pin.

The AD8158 I²C interface can be run in the standard (100 kHz) and fast (400 kHz) modes. The SDA line only changes value when the SCL pin is low with two exceptions. To indicate the beginning or continuation of a transfer, the SDA pin is driven low while the SCL pin is high, and to indicate the end of a transfer, the SDA line is driven high while the SCL line is high. Therefore, it is important to control the SCL clock to toggle only when the SDA line is stable unless indicating a start, repeated start, or stop condition.

I²C INTERFACE DATA TRANSFERS: DATA WRITE

To write data to the AD8158 register set, a microcontroller or any other I²C master needs to send the appropriate control signals to the AD8158 slave device. The following steps need to be taken, where the signals are controlled by the I²C master, unless otherwise specified. For a diagram of the procedure, see Figure 43.

1. Send a start condition (while holding the SCL line high, pull the SDA line low).
2. Send the AD8158 part address (seven bits) whose upper four bits are the static value b1010 and whose lower three bits are controlled by the I2C_A[2:0] input pins. This transfer should be MSB first.
3. Send the write indicator bit (0).
4. Wait for the AD8158 to acknowledge the request.

5. Send the register address (eight bits) to which data is to be written. This transfer should be MSB first.
6. Wait for the AD8158 to acknowledge the request.
7. Send the data (eight bits) to be written to the register whose address was set in Step 5. This transfer should be MSB first.
8. Wait for the AD8158 to acknowledge the request.
- 9a. Send a stop condition (while holding the SCL line high, pull the SDA line high) and release control of the bus.
- 9b. Send a repeated start condition (while holding the SCL line high, pull the SDA line low) and continue with Step 2 in this procedure to perform another write.
- 9c. Send a repeated start condition (while holding the SCL line high, pull the SDA line low) and continue with Step 2 of the read procedure (in the I²C Interface Data Transfers: Data Read section) to perform a read from another address.
- 9d. Send a repeated start condition (while holding the SCL line high, pull the SDA line low) and continue with Step 8 of the read procedure (in the I²C Interface Data Transfers: Data Read section) to perform a read from the same address set in Step 5.

In Figure 43, the AD8158 write process is shown. The SCL signal is shown along with a general write operation and a specific example. In this example, the value 0x92 is written to Address 0x6D of an AD8158 device with a part address of 0x53. The part address is seven bits wide and is composed of the AD8158 static upper four bits (b1010) and the pin-programmable lower three bits (I2C_A[2:0]). The address pins are set to b011. In Figure 43, the corresponding step number is visible in the circle under the waveform. The SCL line is driven by the I²C master and never by the AD8158 slave. As for the SDA line, the data in the shaded polygons is driven by the AD8158, whereas the data in the nonshaded polygons is driven by the I²C master. The end phase case shown is that of Step 9A.

It is important to note that the SDA line only changes when the SCL line is low, except for the case of sending a start, stop, or repeated start condition (Step 1 and Step 9 in this case).

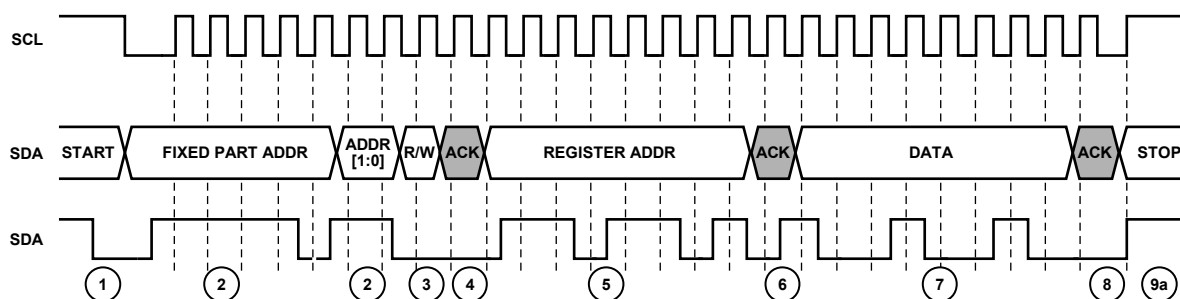

Figure 43. I²C Write Diagram

0166-029

I²C INTERFACE DATA TRANSFERS: DATA READ

To read data from the AD8158 register set, a microcontroller or any other I²C master needs to send the appropriate control signals to the AD8158 slave device. The following steps need to be taken, where the signals are controlled by the I²C master, unless otherwise specified. For a diagram of the procedure, see Figure 44.

1. Send a start condition (while holding the SCL line high, pull the SDA line low).
2. Send the AD8158 part address (seven bits) whose upper four bits are the static value b1010 and whose lower three bits are controlled by the I2C_A[2:0] input pins. This transfer should be MSB first.
3. Send the write indicator bit (0).
4. Wait for the AD8158 to acknowledge the request.
5. Send the register address (eight bits) from which data is to be read. This transfer should be MSB first. The register address is kept in memory in the AD8158 until the part is reset or the register address is written over with the same procedure (Step 1 to Step 6).
6. Wait for the AD8158 to acknowledge the request.
7. Send a repeated start condition (while holding the SCL line high, pull the SDA line low).
8. Send the AD8158 part address (seven bits) whose upper four bits are the static value b1010 and whose lower three bits are controlled by the I2C_A[2:0] input pins. This transfer should be MSB first.
9. Send the read indicator bit (1).
10. Wait for the AD8158 to acknowledge the request.
11. The AD8158 then serially transfers the data (eight bits) held in the register indicated by the address set in Step 5.
12. Acknowledge the data.

- 13a. Send a stop condition (while holding the SCL line high, pull the SDA line high) and release control of the bus.
- 13b. Send a repeated start condition (while holding the SCL line high, pull the SDA line low) and continue with Step 2 of the write procedure (see the I2C Interface Data Transfers: Data Write section) to perform a write.
- 13c. Send a repeated start condition (while holding the SCL line high, pull the SDA line low) and continue with Step 2 of this procedure to perform a read from another address.
- 13d. Send a repeated start condition (while holding the SCL line high, pull the SDA line low) and continue with Step 8 of this procedure to perform a read from the same address.

In Figure 44, the AD8158 read process is shown. The SCL signal is shown along with a general read operation and a specific example. In this example, the value 0x49 is read from Address 0x6D of an AD8158 device with a 0x53 part address. The part address is seven bits wide and is composed of the AD8158 static upper four bits (b1010) and the pin-programmable lower three bits (I2C_A[2:0]). The address pins are set to b011. In Figure 44, the corresponding step number is visible in the circle under the waveform. The SCL line is driven by the I²C master and never by the AD8158 slave. As for the SDA line, the data in the shaded polygons is driven by the AD8158, whereas the data in the nonshaded polygons is driven by the I²C master. The end phase case shown is that of Step 13A.

It is important to note that the SDA line only changes when the SCL line is low, except for the case of sending a start, stop, or repeated start condition, as in Step 1, Step 7, and Step 13. In Figure 44, A is the same as ACK. Equally, Sr represents a repeated start where the SDA line is brought high before SCL is raised. SDA is then dropped while SCL is still high.

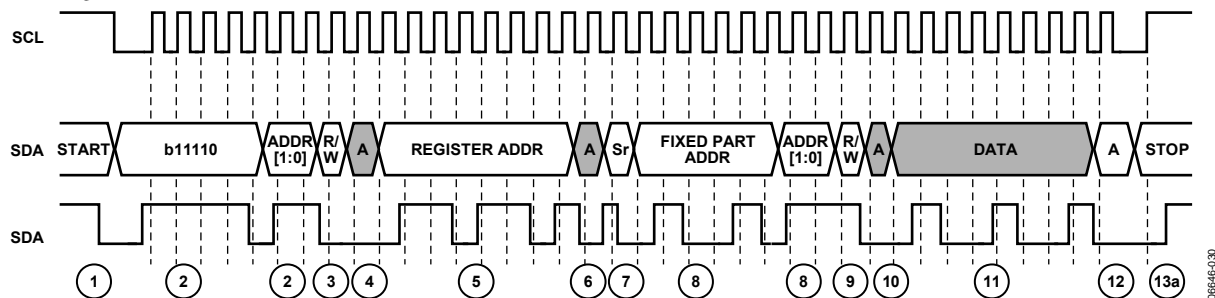

Figure 44. I²C Read Diagram

APPLICATIONS INFORMATION

SUPPLY SEQUENCING

Ideally, all power supplies should be brought up to the appropriate levels simultaneously (power supply requirements are set by the supply limits in Table 1 and the absolute maximum ratings listed in Table 3). In the event that the power supplies to the AD8158 are brought up separately, the supply power-up sequence is as follows: DV_{CC} powered first, followed by V_{CC} , and lastly V_{TTI} and V_{TTO} . The power-down sequence is reversed with V_{TTI} and V_{TTO} being powered off first.

V_{TTI} and V_{TTO} contain ESD protection diodes to the V_{CC} power domain (see Figure 38 and Figure 39). To avoid a sustained high current condition in these devices ($I_{SUSTAINED} < 100$ mA), the V_{TTI} and V_{TTO} supplies should be powered on after V_{CC} and should be powered off before V_{CC} .

If the system power supplies have a high impedance in the powered off state, then supply sequencing is not required provided the following limits are observed:

- Peak current from V_{TTI} or V_{TTO} to $V_{CC} < 200$ mA
- Sustained current from V_{TTI} or V_{TTO} to $V_{CC} < 100$ mA

SINGLE SUPPLY vs. MULTIPLE SUPPLY OPERATION

The AD8158 supports a flexible supply voltage of 1.8 V to 3.3 V. For some dc-coupled links, 1.2 V or ground-referenced signaling may be desired. In these cases, the AD8158 can be run with a split supply configuration.

Table 22. Alternate Supply Configuration Examples

Signal Level	V_{CC} , V_{TTI} , V_{TTO}	V_{EE}
1.2 V CML	1.2 V	$-2.1 \text{ V} \leq V_{EE} \leq -0.6 \text{ V}$
GND – 400 mV diff	GND	$-3.3 \text{ V} \leq V_{EE} \leq +1.8 \text{ V}$

The AD8158 control signals are always referenced between DV_{CC} and V_{EE} and, when using a split supply configuration, logic level-shift circuits should be used. The evaluation board design shows the use of the Analog Devices, Inc., ADUM1250 I²C isolator and a level shifter to level-shift the SCL and SDA signals.

Evaluation of DC-Coupled Links

When evaluating the AD8158 dc-coupled, remember that most lab equipment is ground referenced while the AD8158 high speed I/O are connected by 50 Ω on-die termination resistors to V_{TTI} and V_{TTO} . To interface the AD8158 to ground-referenced, high speed instrumentation (for example, the 50 Ω inputs of a high speed oscilloscope), it is necessary to level-shift the outputs by either using a dc-blocking network or by powering the AD8158 between ground and a negative supply.

For example, to evaluate 1.8 V dc-coupled transmitter performance with a 50 Ω ground-referenced oscilloscope, use the following supply configuration:

$$V_{CC} = V_{TTO} = V_{TTI} = \text{Ground}$$

$$V_{EE} = -1.8 \text{ V}$$

$$\text{Ground} < DV_{CC} < 1.5 \text{ V}$$

REGISTER MAP

All registers are port-level and global registers, unless otherwise noted.

Table 23. Register Definitions

Mnemonic	Addr.	Bit 7	Bit 6	Bit 5	Bit 4	Bit 3	Bit 2	Bit 1	Bit 0	Default
Reset	0x00								RESET	
Switch Control 1	0x01		LBC	LBB	LBA	SELAB/B[3]	SELAB/B[2]	SELAB/B[1]	SELAB/B[0]	0x00
Switch Control 2	0x02				SEL4G				BICAST	0x00
Global Squelch Ctrl	0x04					GSQLCH_ENB				0x0F
Switch Core/Headroom Mode	0x05		TX_HEAD ROOM_C	TX_HEAD ROOM_B	TX_HEAD ROOM_A				XCORE_ENB	0x01
RXA Disable	0x40					RXDIS A3	RXDIS A2	RXDIS A1	RXDIS A0	0x00
RXA Setting	0x41					AEQ[3]	AEQ[2]	AEQ[1]	AEQ[0]	0x00
RXA LOS Threshold	0x50	Set to 0	Set to 0	THRBIT[5]	THRBIT[4]	THRBIT[3]	THRBIT[2]	THRBIT[1]	THRBIT[0]	0x1C
RXA LOS Control	0x51	Set to 0	Set to 0	Set to 0	Set to 0	Set to 0	LOS_FILT	LOS_GSEL	LOS_ENB	0x07
RXA Lane 1/ RXA Lane 0 Setting	0x42 ¹	A1EQ[3]	A1EQ[2]	A1EQ[1]	A1EQ[0]	A0EQ[3]	A0EQ[2]	A0EQ[1]	A0EQ[0]	0x00
RXA Lane 3/ RXA Lane 2 Setting	0x43 ¹	A3EQ[3]	A3EQ[2]	A3EQ[1]	A3EQ[0]	A2EQ[3]	A2EQ[2]	A2EQ[1]	A2EQ[0]	0x00
RXA P/N Swap	0x44 ¹					PNA3	PNA2	PNA1	PNA0	0x00
RXA LOS Status	0x45 ¹	LOSA3 Sticky	LOSA2 Sticky	LOSA1 Sticky	LOSA0 Sticky	LOSA3 Active	LOSA2 Active	LOSA1 Active	LOSA0 Active	
TXA Disable	0x48					TXDIS A3	TXDIS A2	TXDIS A1	TXDIS A0	0x00
TXA Level/PE Control	0x49			ALEV[1]	ALEV[0]		APE[2]	APE[1]	APE[0]	0x20
TXA Lane1/ TXA Lane 0 PE Setting	0x4A ¹		A1PE[2]	A1PE[1]	A1PE[0]		A0PE[2]	A0PE[1]	A0PE[0]	0x00
TXA Lane2/3 PE Setting	0x4B ¹		A3PE[2]	A3PE[1]	A3PE[0]		A2PE[2]	A2PE[1]	A2PE[0]	0x00
TXA Per-Lane Level Setting	0x4C ¹	A3OLEV[1]	A3OLEV[0]	A2OLEV[1]	A2OLEV[0]	A1OLEV[1]	A1OLEV[0]	A0OLEV[1]	A0OLEV[0]	0xAA
RXB Disable	0x80					RXDIS B3	RXDIS B2	RXDIS B1	RXDIS B0	0x00
RXB Setting	0x81					BEQ[3]	BEQ[2]	BEQ[1]	BEQ[0]	0x00
RXB LOS Threshold	0x90	Set to 0	Set to 0	THRBIT[5]	THRBIT[4]	THRBIT[3]	THRBIT[2]	THRBIT[1]	THRBIT[0]	0x1C
RXB LOS Ctrl	0x91	Set to 0	Set to 0	Set to 0	Set to 0	Set to 0	LOS_FILT	LOS_GSEL	LOS_ENB	0x07
RXB Lane 1/ RXB Lane 0 Setting	0x82 ¹	B1EQ[3]	B1EQ[2]	B1EQ[1]	B1EQ[0]	B0EQ[3]	B0EQ[2]	B0EQ[1]	B0EQ[0]	0x00
RXB Lane 3/ RXB Lane 2 Setting	0x83 ¹	B3EQ[3]	B3EQ[2]	B3EQ[1]	B3EQ[0]	B2EQ[3]	B2EQ[2]	B2EQ[1]	B2EQ[0]	0x00
RXB P/N Swap	0x84 ¹					PNB3	PNB2	PNB1	PNB0	0x00
RXB LOS Status	0x85 ¹	LOSB3 Sticky	LOSB2 Sticky	LOSB1 Sticky	LOSB0 Sticky	LOSB3 Active	LOSB2 Active	LOSB1 Active	LOSB0 Active	
TXB Disable	0x88					TXDIS B3	TXDIS B2	TXDIS B1	TXDIS B0	0x00
TXB Level/PE Control	0x89			BLEV[1]	BLEV[0]		BPE[2]	BPE[1]	BPE[0]	0x20
TXB Lane1/ TXB Lane 0 PE Setting	0x8A ¹		B1PE[2]	B1PE[1]	B1PE[0]		B0PE[2]	B0PE[1]	B0PE[0]	0x00

Mnemonic	Addr.	Bit 7	Bit 6	Bit 5	Bit 4	Bit 3	Bit 2	Bit 1	Bit 0	Default
TXB Lane2/ TXB Lane 3 PE Setting	0x8B ¹		B3PE[2]	B3PE[1]	B3PE[0]		B2PE[2]	B2PE[1]	B2PE[0]	0x00
TXB Per-Lane Level Setting	0x8C ¹	B3OLEV[1]	B3OLEV[0]	B2OLEV[1]	B2OLEV[0]	B1OLEV[1]	B1OLEV[0]	B0OLEV[1]	B0OLEV[0]	0xAA
RXC Disable	0xC0					RXDIS C3	RXDIS C2	RXDIS C1	RXDIS C0	0x00
RXC Setting	0xC1					CEQ[3]	CEQ[2]	CEQ[1]	CEQ[0]	0x00
RXC LOS Threshold	0xD0	Set to 0	Set to 0	THRBIT[5]	THRBIT[4]	THRBIT[3]	THRBIT[2]	THRBIT[1]	THRBIT[0]	0x1C
RXC LOS Ctrl	0xD1	Set to 0	Set to 0	Set to 0	Set to 0	Set to 0	LOS_FILTER	LOS_GSEL	LOS_ENB	0x07
RXC Lane 1/ RXC Lane 0 Setting	0xC2 ¹	C1EQ[3]	C1EQ[2]	C1EQ[1]	C1EQ[0]	C0EQ[3]	C0EQ[2]	C0EQ[1]	C0EQ[0]	0x00
RXC Lane 3/ RXC Lane 2 Setting	0xC3 ¹	C3EQ[3]	C3EQ[2]	C3EQ[1]	C3EQ[0]	C2EQ[3]	C2EQ[2]	C2EQ[1]	C2EQ[0]	0x00
RXC P/N Swap	0xC4 ¹					PNC3	PNC2	PNC1	PNC0	0x00
RXC LOS Status	0xC5 ¹	LOSC3 Sticky	LOSC2 Sticky	LOSC1 Sticky	LOSC0 Sticky	LOSC3 Active	LOSC2 Active	LOSC1 Active	LOSC0 Active	
TXC Disable	0xC8					TXDIS C3	TXDIS C2	TXDIS C1	TXDIS C0	0x00
TXC Level/PE Control	0xC9			CLEV[1]	CLEV[0]		CPE[2]	CPE[1]	CPE[0]	0x20
TXC Lane1/ TXC Lane 0 PE Setting	0xCA ¹		C1PE[2]	C1PE[1]	C1PE[0]		C0PE[2]	C0PE[1]	C0PE[0]	0x00
TXC Lane2/ TXC Lane 3 PE Setting	0xCB ¹		C3PE[2]	C3PE[1]	C3PE[0]		C2PE[2]	C2PE[1]	C2PE[0]	0x00
TXC Per-Lane Level Setting	0xCC ¹	C3OLEV[1]	C3OLEV[0]	C2OLEV[1]	C2OLEV[0]	C1OLEV[1]	C1OLEV[0]	C0OLEV[1]	C0OLEV[0]	0xAA

¹ Per-lane registers.

OUTLINE DIMENSIONS

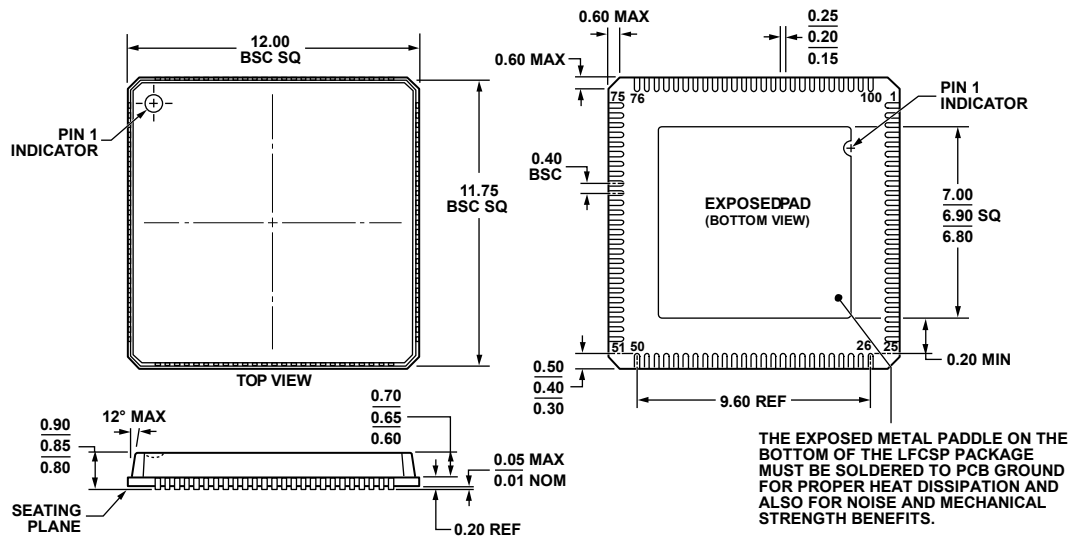

COMPLIANT TO JEDEC STANDARDS MO-220-VRRE.

Figure 45. 100-Lead Lead Frame Chip Scale Package [LFCSP_VQ]
 12 mm × 12 mm Body, Very Thin Quad
 (CP-100-1)
 Dimensions shown in millimeters

061108-B

ORDERING GUIDE

Model	Temperature Range	Package Description	Package Option
AD8158ACPZ ¹	-40°C to +85°C	100-Lead Lead Frame Chip Scale Package [LFCSP_VQ]	CP-100-1
AD8158-EVALZ ¹		Evaluation Board	

¹ Z = RoHS Compliant Part.

NOTES

AD8158

NOTES

Purchase of licensed I²C components of Analog Devices or one of its sublicensed Associated Companies conveys a license for the purchaser under the Philips I²C Patent Rights to use these components in an I²C system, provided that the system conforms to the I²C Standard Specification as defined by Philips.

©2008 Analog Devices, Inc. All rights reserved. Trademarks and registered trademarks are the property of their respective owners.
D06646-0-6/08(0)



www.analog.com